

Euromaid

USER MANUAL

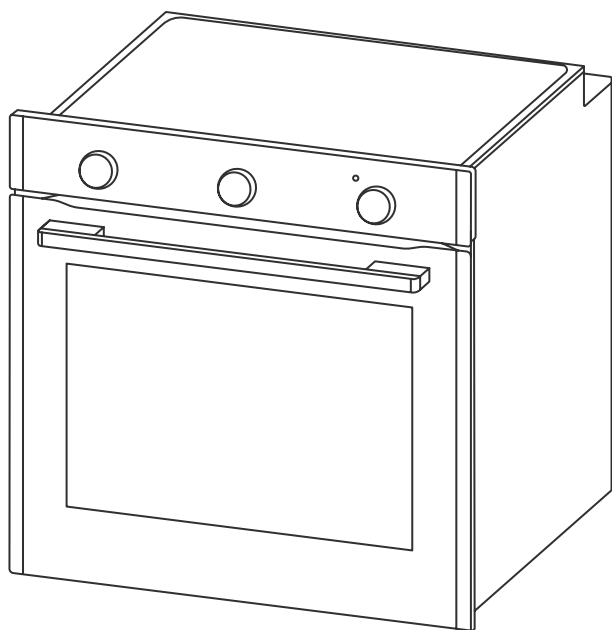

EO605MTS

60cm Built-in Oven

PLEASE READ THE USER MANUAL CAREFULLY BEFORE USING THE UNIT

Dear Customer,

Congratulations on the purchase of your new product from **Euromaid**.

We recommend you please take some time to read the instruction manual thoroughly to familiarise yourself with the functionality and operations to ensure optimum performance of your new appliance.

After reading the manual, please store it in a safe and accessible location for future reference.

Installation

The installation of your new appliance must be carried out by a qualified installer / technician in accordance to local regulations. Please ensure all packaging materials are disposed of correctly.

Customer Care

Our Customer Care centre is available should you wish to learn more about your appliance in relation to how to use it to its best potential, or tips on cleaning as well as available accessories.

For further details please contact our Customer Care Team

Australia

Ph: 1300 556 816
customer.care.ha@glendimplex.com.au

New Zealand

Ph: 09 274 8265
nztechserv@glendimplex.co.nz



Thank you.

Regards,

Euromaid Australia and New Zealand

CONTENTS

Safety Information	4 - 7
Warnings	6
Environment Protection	7
Product Overview	8 - 10
Controls	9
Oven and Accessories	9
Cooking Modes	10
Installation	11 - 13
Cabinet Details	11
Daily Use	14 - 15
Positioning the Oven Trays & Shelves	14
How to Use Your Oven	15
Hints & Tips	17 - 20
Cooking Advice	17
Cooking Guide	20
Cleaning & Maintenance	22 - 25
How to Remove the Oven Door	23
How to Dismantle the Oven Door for Cleaning	24
Replacing the Oven Lamp	25
Product Information	26
Manufacturer Gurantee	27 - 29

Icon	Type	Meaning
	Warning	Serioud injury or death risk
	Caution	Injury or property damage risk
	Important / note	Operating the system correctly

SAFETY INFORMATION

We recommend that you read the instructions in this owner's manual carefully before use for the best performance and to extend the life of your appliance. It will provide you with all the information you need to ensure its safe installation, use and maintenance. Retain this owner's manual for future reference.

When handling the appliance, we recommend you always use the handles recessed into the sides of the oven to prevent personal injury or damage to the appliance.

To maintain the efficiency and safety of this appliance, we recommend that you do the following:

- Always call the Glen Dimplex service department if there are any faults with your appliance.
- Always use original spare parts available from Glen Dimplex.
- This appliance is designed for non-commercial, household use and it must not be altered in any way.

⚠ Warning! This appliance is a domestic kitchen appliance suitable for indoor installation. It is not suitable for outdoor installations such as alfresco kitchens or garages unless a qualified, competent installer has deemed the location and installation to be suitable & compliant.

- This appliance can only be used safely when it is correctly connected to an efficient earthing system in compliance with current electrical safety standards.
- If the supply cord is damaged, it must be replaced by the manufacturer or its service agent or a similarly qualified person in order to avoid a hazard.
- During use, the appliance becomes hot. Care should be taken to avoid touching heating elements inside the oven.

⚠ Warning! Accessible parts will become hot when in use.

- To avoid burns and scalds, children should be kept away.
- This appliance is not intended for use by persons (including children) with reduced physical, sensory or mental capabilities, or lack of experience and knowledge, unless they have been given supervision or instruction concerning use of the appliance by a person responsible for their safety.
- Young children should be supervised to ensure that they do not play with the appliance.
- Do not use a steam cleaner to clean the appliance.

SAFETY INFORMATION

Packaging items such as plastic bags, polystyrene, nails, etc. are potentially dangerous, and therefore appropriate measures must be taken to prevent children and the disabled from coming into contact with them.

Avoid the following:

- Touching the appliance with wet parts of the body.
- Using the appliance while barefoot.
- Improper or dangerous operation.
- Obstructing the ventilation or heat dissipation slots.
- Allowing power supply cables of other appliances to come into contact with hot parts of the oven.
- Exposing the appliance to atmospheric agents such as rain, or direct sunlight.
- Using the oven for storage purposes.
- Using flammable liquids near the appliance.

Authorised personnel must be contracted to:

- Install the appliance according to these installation instructions and any local requirements.
- Replace the temperature probe if it is damaged. The probe is part of thermostat. Only use the temperature sensing probe recommended for this oven.

Glen Dimplex Service Department must be contacted:

- If in doubt about the operation of the appliance.
- If in doubt about the soundness of the appliance after removing it from its packaging.
- If the power supply cable has been damaged or needs to be replaced.
- If the appliance requires a service.
- If you need spare parts.

SAFETY INFORMATION

Warnings

- ⚠ **Warning!** Do not steam clean the oven.
- ⚠ **Warning!** Do not use harsh abrasive cleaners or sharp metal scrapers to clean the oven door glass since they can scratch the surface, which may result in shattering of the glass.
- ⚠ **Warning!** Do not install the appliance behind a decorative door in order to avoid overheating.
- ⚠ **Warning!** Only use the appliance to cook food and nothing else.
- ⚠ **Warning!** Check that the appliance has not been damaged immediately after it has been unpacked.
- ⚠ **Warning!** Disconnect the appliance from the electrical mains if it is not functioning properly and before cleaning or performing maintenance.
- ⚠ **Warning!** When left unused for a long period, unplug the appliance from the electricity mains.
- ⚠ **Warning!** Use oven gloves to place cookware in the oven or when removing it.
- ⚠ **Warning!** Always grip the oven door handle in the centre.
- ⚠ **Warning!** Make sure the knobs are in the **off** position when the appliance is not in use.
- ⚠ **Warning!** Glen Dimplex will not accept any liability as a result of any damage due to incorrect installation or improper use.

SAFETY INFORMATION

Environment Protection

The appliance shall not be discarded together with the urban refuse and rubbish. The materials used on this appliance marked by the symbol  are recyclable.



The symbol on the product or on its packaging indicates that this product may not be treated as household waste. Instead it should be taken to the appropriate collection point for the recycling of electrical and electronic equipment. By ensuring this product is disposed of correctly, you will help prevent potential negative consequences for the environment and human health, which could otherwise be caused by inappropriate waste handling of this product. For more details information about recycling of this product, please contact your local council, your household waste disposal service or the shop where you purchased the product.

Packaging Materials

The materials with the symbol are recyclable.

Dispose the packaging in a suitable collection containers to recycle it.

PRODUCT OVERVIEW

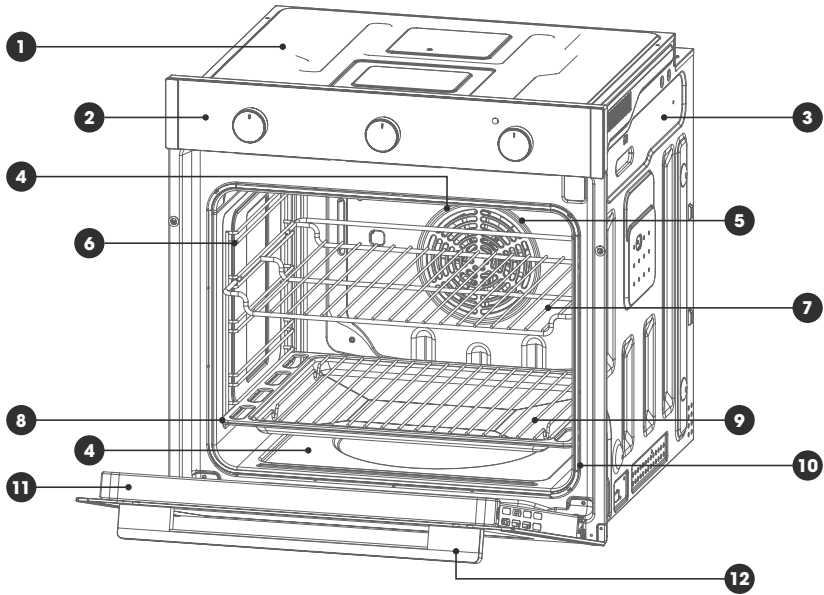

① Top panel

② Control panel

③ Side panel

④ Element

⑤ Fan and element cover

⑥ Side racks

⑦ Chrome wire shelf

⑧ Baking tray

⑨ Grill insert

⑩ Door seal

⑪ Oven door

⑫ Oven door handle

① **Note:** Above picture is for reference only. The actual appliance maybe slightly different.

PRODUCT OVERVIEW

Controls

- ① Cooking mode selection knob
- ② Timer / manual mode selection knob
- ③ Cooking temperature selection knob

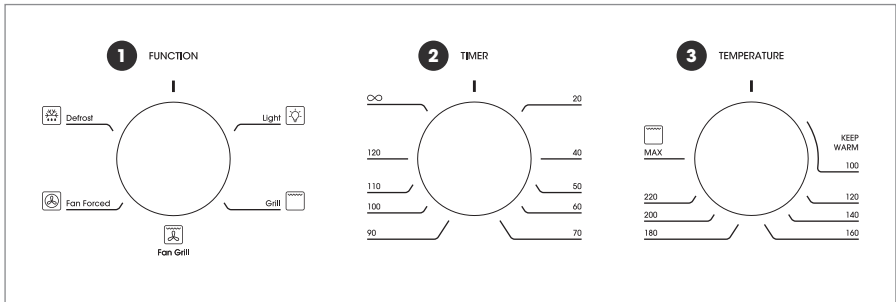

Oven and Accessories

There are five shelf positions in the oven. The oven is supplied with:

- ① 2x chrome wire shelf supports
- ② 1x baking tray
- ③ 1x grill insert

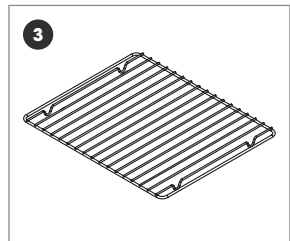
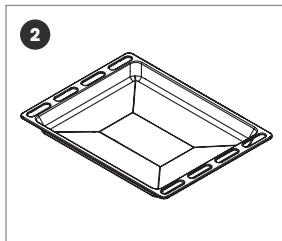
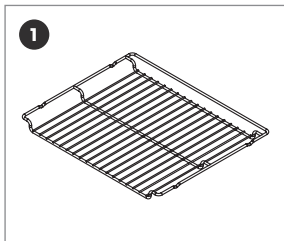
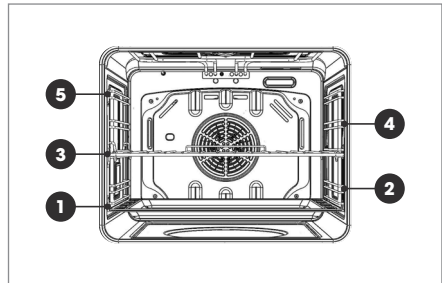

PRODUCT OVERVIEW

Cooking Modes



Grill

Directs radiant heat from the powerful upper element onto the food. The **grill** function is best suited for cooking different cuts of meat such as steak, chops, sausages and fish, or for making toasted sandwiches and other quick-cooking foods. For the best results, allow the grill to preheat for 3 minutes before placing food inside. This will help to seal in the natural juices and maintain tenderness of meats. Always grill with the oven door closed.



Fan Grill

Generates heat from the upper element which is circulated throughout the cavity by the fan. This combination helps to distribute the heat more evenly onto the food, which helps to avoid burning or overcooking. The **fan grill** function is ideal for larger cuts of meat which require longer cooking times and will achieve results similar to rotisserie cooked meat. Use the **fan grill** function with the oven door closed.



Fan Forced

Uses the rear element surrounding the fan to generate heat. The fan then circulates the hot air to maintain a consistent temperature throughout the oven cavity. This allows you to cook food in different areas of the oven at the same time. **Fan forced** is a very versatile cooking function which can be used for most types of cooking and baking, and will cook foods faster and at a lower temperature than standard **bake** functions.



Defrost

Uses the fan to circulate room temperature air around the cavity. This function helps to defrost (thaw) different kinds of food before cooking. Using the **defrost** function will reduce defrosting times by up to 50%.



Light

Turns on only the oven light, the light remains on when the oven is operating.

INSTALLATION

- ① **Important!** Installation, assembly and electrical connections must be carried out by authorised personnel.

Cabinet Details

In order to ensure that the built-in appliance functions properly, the cabinet containing it must be appropriate. The figure below gives the dimensions of the cut-out for installation under the counter or in a wall cabinet unit.

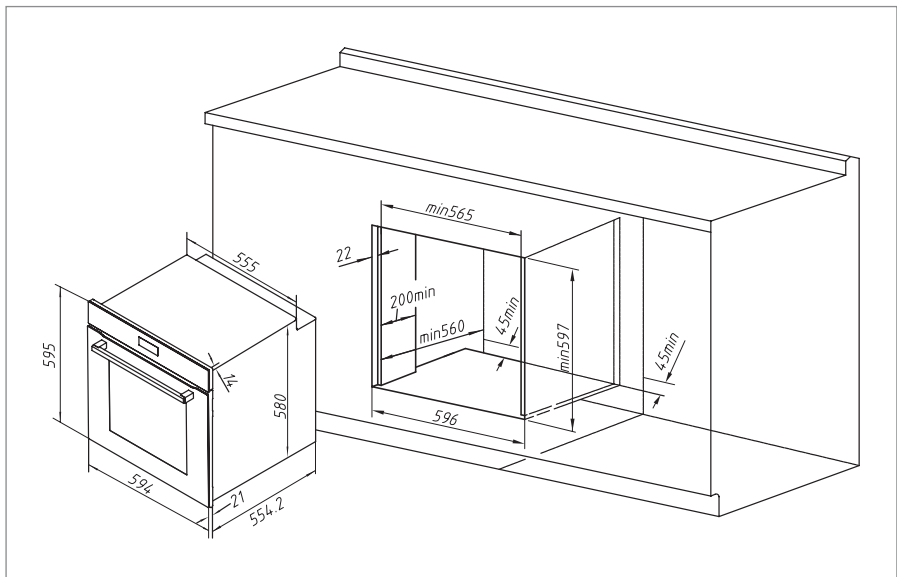
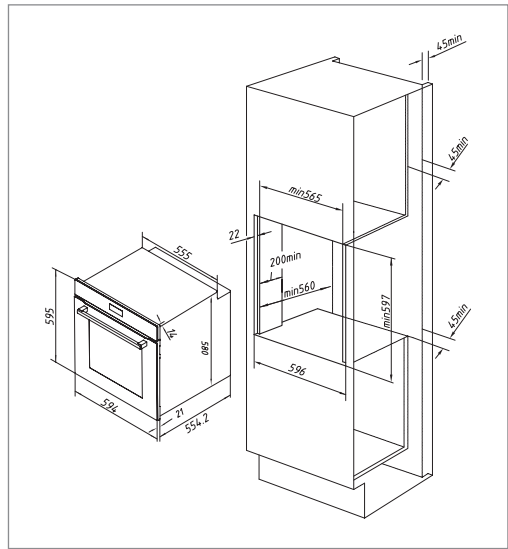

INSTALLATION

The panels of the adjacent cabinets must be made of heat resistant material. In particular, cabinets with a veneer exterior must be assembled with glues which can withstand temperatures of up to 75°C.

In compliance with current safety standards, contact with the electrical parts of the oven must not be possible once it has been installed.

All parts, which ensure the safe operation of the appliance, must be removable only with the aid of a tool.

To fasten the oven to the cabinet, open the door of the oven and attach it by inserting the 2 wood screws into the 2 holes located on the perimeter of the frame.

Electrical connection

- The appliance is usually supplied fitted with a power cord and 3 pin plug. Install the cooker so that the plug is easily accessible. Plug the 3-pin plug into a properly earthed, 10A general purpose power outlet preferably on a separate dedicated circuit. The supply cable should be positioned so that it does not reach a temperature of more than 75°C along its entire length.
- If the appliance is not supplied with a plug or if connecting the cable directly to the mains, connection to the electricity supply must be made by an authorised person in accordance with the Wiring Rules AS/NZS3000. The installation must include a suitable isolating switch with a minimum contact opening of 3mm between the appliance and the mains. The isolating switch should be sized according to the load on the data label and should comply with current regulations (the earth wire should not be interrupted by the circuit breaker).

INSTALLATION

Before making the connection

- Check that the switch, wiring and electrical system can support the appliance load (see data plate);
- Check the power supply system has an efficient earthing connection which complies with the provisions of current regulations;
- Check the power outlet or omnipoar circuit-breaker is easily accessible once the cooker has been installed.

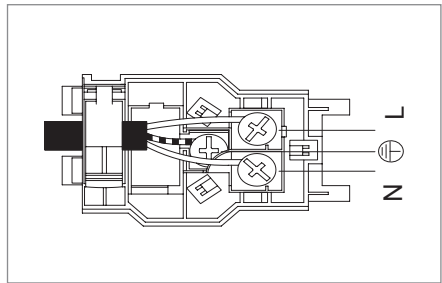
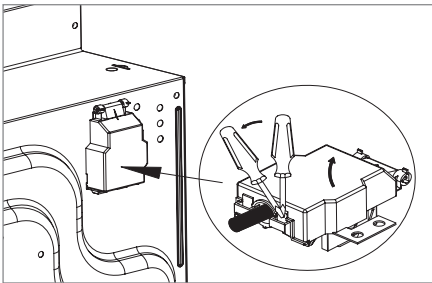

Replacing the power supply lead

- If the supply cord or plug is damaged, it must be replaced by the manufacturer or its service agent or a similarly qualified person in order to avoid hazard.

⚠ Warning! All electrical connections must be made by a suitably qualified and licenced person in accordance with local regulations. Glen Dimplex will not be held responsible for damages caused to cabinetry due to incorrect installation.

DAILY USE

Positioning the Oven Trays & Shelves

- The Grill Tray or Oven Shelf can be located in any of the five height positions in the oven. Refer to the **cooking guide table** for the recommended shelf position. When fitting the trays or shelves, ensure they are fitted between the two wires that are closest together as shown below.
 - Oven Shelves have a stop so that they are not fully withdrawn by accident. To fully remove the oven shelves, lift the front of the shelf slightly and withdraw fully from the oven.
- ① **Note:** that the Baking Tray does not have a stop position and can be fully withdrawn without interruption, so be careful not to accidentally fully withdraw the tray.
- Fit trays and shelves between bars as shown below.
 - To remove the oven side racks, push the wire support backwards towards the rear of the oven cavity to release from the locking pin. Once released, the side racks can be removed by gently pulling out of the positioning holes in the oven walls, towards the centre of the oven. To replace the side racks, repeat steps in reverse procedure.

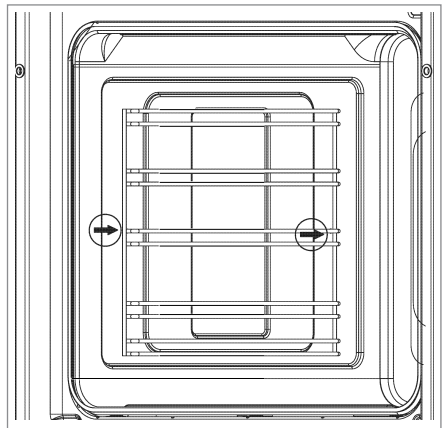
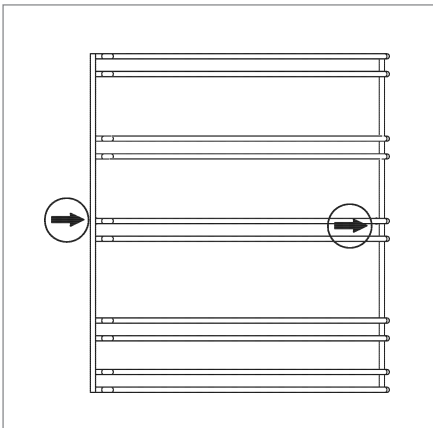

DAILY USE

How to Use Your Oven

This fan forced oven is an extremely versatile appliance that allows you to choose easily and safely between different cooking modes. The various cooking modes are selected by means of a cooking mode selection knob, located on the control panel.

To operate the oven

- Ensure that manual mode or timer is selected (page 11).
 - Turn the cooking mode selection knob to the desired cooking mode (explanation of cooking modes is on pages 10 to 11).
 - Turn the cooking temperature selection knob to the desired temperature (cooking guide is on page 16) or to **Max** if Grilling.
 - The first time you use your appliance, we recommend that you set the thermostat to the highest setting, set the cooking mode selection knob to a cooking mode and leave the oven on for about half an hour with nothing in it and the oven door closed. Then, open the oven door and allow the oven to cool. Any odour that may be detected during this initial use is due to the evaporation of substances used to protect the oven during storage.
- ① **Note:** Place tray on the bottom shelf position of the oven to prevent any spillages from dripping onto the bottom of the oven. Never place anything (including foil and oven trays) on the bottom of the oven when it is in operation because this could damage the enamel. Only place your cookware (dishes, trays, aluminum foil, etc.) on the oven shelves provided with the appliance.

DAILY USE

Mechanical timer

- ① The Mechanical Timer automatically controls when the oven turns off. It cannot automatically switch the oven on, only off. To ensure tension is kept on the spring, turn the timer knob to 120min setting and then back to the required cooking time.
 - ② The timer can be set between 10mins and 120mins. At the end of the selected time period, the timer will sound and automatically turn off the oven.
 - ③ To operate the oven manually, set the timer to ∞ by turning anti-clockwise from the off **0** position.
- ① **Note:** When the timer is in the 12 o'clock **off** position, the oven will not operate.

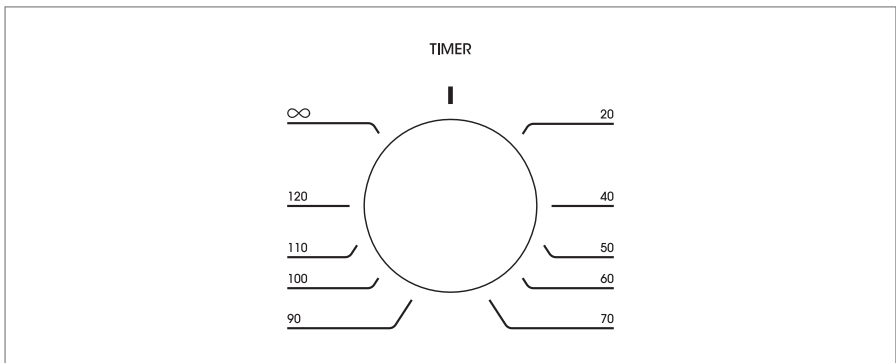

The oven light

- Set the cooking mode selection knob to the  symbol to switch on the oven light. The oven light remains on when the oven is operating.

Cooling ventilation

- In order to cool down the exterior of the appliance, this model is equipped with a cooling fan, which switches on automatically.
 - When the cooling fan is on, you will notice a flow of air exiting between the oven door and the control panel.
- ① **Note:** When cooking is finished, the cooling fan continues to operate until the oven cools down and then switches off automatically.

HINTS & TIPS



Cooking Advice

The oven offers a range of settings which allow you to cook any type of food in the best possible way. With time you will learn to make the best use of this versatile cooking appliance and the following directions are only a guideline which may be varied according to your own personal experience.



Preheating

- If the oven needs to be preheated, the **fan forced mode**  should be selected. This is the most efficient mode, which will reach the desired temperature as quickly as possible using the least amount of energy.
- Once the food has been placed in the oven, the desired cooking mode can then be selected.

Multi shelf cooking



- If you want to cook food on several shelves, select the **fan forced mode** .
- When cooking delicate foods on more than one shelf, use the **fan forced mode** . This mode allows you to cook on 3 shelves at the same time. Refer to the **cooking guide** table.

Using the grill

- This multi-function oven has 2 different grilling modes.
 - Use the **grill mode**  with the oven door closed, place the food on the centre of the grill pan, insert and fit the grill pan on either the 3rd or 4th shelf from the bottom.
- ① **Note:** Only the central part of the top heating element operates for grilling.
- When using **grill mode** , we recommend you set the thermostat to the highest setting.

HINTS & TIPS

Using fan grill

- Use **fan grill mode**  with the oven door closed. This mode is very useful for grilling foods rapidly, as the distribution of heat by the fan makes it possible not only to brown the surface, but also to cook the bottom of the food.
 - It can also be used for browning foods at the end of the cooking process, such as adding that gratin finish to pasta bakes for example.
 - When using **fan grill mode** , place the food on the 2nd or 3rd oven shelf from the bottom, then place a dripping-pan on the 1st rack from the bottom to prevent fat and grease from dripping onto the oven floor. We recommend you set the thermostat to 180°C, as it is the most efficient temperature for **fan grill mode** .
 - However, this does not mean you cannot use other temperatures, simply adjust the thermostat knob to the desired temperature.
- ① **Important!** For best results and to save energy, always use the grill functions with the oven door closed.

Baking cakes

- When baking cakes, always place them in a preheated oven. Make sure you wait until the oven has been preheated thoroughly (the indicator light will turn off). To prevent heat loss and the cake from dropping, do not open the oven door during baking.
- **In general, if pastry is too dry:** increase the temperature by 10°C and reduce the cooking time.
- **If pastry has dropped:** use less liquid or lower the temperature by 10°C.
- **If pastry is too dark on top:** place it on a lower shelf, lower the temperature, and increase the cooking time.
- **If cooked well on the inside but sticky on the outside:** use less liquid, lower the temperature, and increase the cooking time.
- **If the pastry sticks to the pan:** grease the pan well and sprinkle it with a dusting of flour or use greaseproof paper.
- **If I used multi shelf cooking and one shelf is more cooked:** use a lower temperature setting next time. It is not necessary to remove the food from all the racks at the same time.

HINTS & TIPS

Cooking pizza



- For best results when cooking pizza, use the **fan forced mode** .
- Preheat the oven for at least 10 minutes.
- Use a light aluminum pizza pan, placing it on the shelf supplied with the oven. Don't use the dripping pan since this will extend the cooking time, making it difficult to get a crispy crust.
- Do not open the oven door frequently while the pizza is cooking;
- If the pizza has a lot of toppings (three or four), we recommend you add the mozzarella cheese on top halfway through the cooking process.
- For best results, only use one shelf at a time, but if you want to cook on two shelves, use the 2nd and 4th racks from the bottom with a temperature of 220°C and swap them halfway through cooking.

Cooking fish and meat

- When cooking white meat and fish, use a temperature setting from 180°C to 200°C.
- For red meat that you want well done on the outside while tender and juicy in the inside, it is best to start with a high temperature setting (200°C-220°C) for a short time, then turn the oven down afterwards.
- In general, the larger the roast, the lower the temperature setting.
- Place the meat on the centre of the shelf and place the dripping pan beneath it to catch the fat.
- Make sure that the shelf is inserted so that it is in the centre of the oven. If you would like to increase the amount of heat from below, use a lower shelf height. For savoury roasts (especially duck and wild game), dress the meat with lard or bacon on the top.

HINTS & TIPS

Cooking Guide

Foods	Weight (kg)	Cooking position*	Preheat time (min)	Temp. setting	Cooking time (min)
 Defrost					
All frozen food					
 Grill					
Soles & cuttlefish	1	4	5	Max	8 - 10
Squid & prawn kebabs	1	4	5	Max	6 - 8
Cod fish	1	4	5	Max	10
Grill vegetables	1	3/4	5	Max	10 - 15
Veal steak	1	4	5	Max	15 - 20
Cutlets	1	4	5	Max	15 - 20
Hamburgers	1	4	5	Max	7 - 10
Mackerels	1	4	5	Max	15 - 20
Toasted sandwiches	-	4	5	Max	2 - 3
 Fan grill					
Grilled chicken	1.5	3	5	200	55 - 60
Cuttlefish	1.5	3	5	200	30 - 35

*Rack position from the bottom

HINTS & TIPS

Foods	Weight (kg)	Cooking position*	Preheat time (min)	Temp. setting	Cooking time (min)
 Fan forced					
Tarts	0.5	3	15	180	20 - 30
Fruit cakes	1	2/3	15	180	40 - 45
Fruit cake	0.7	3	15	180	40 - 50
Sponge cake	0.5	3	15	160	25 - 30
Stuffed pancakes (on 2 shelves)	1.2	2 - 4	15	200	30 - 35
Small cakes (on 2 shelves)	0.6	2 - 4	15	190	20 - 25
Cheese puffs (on 2 shelves)	0.4	2 - 4	15	210	15 - 20
Cream puffs (on 3 shelves)	0.7	1 - 3 - 5	15	180	20 - 25
Biscuits (on 3 shelves)	0.7	1 - 3 - 5	15	180	20 - 25
Meringues (on 3 shelves)	0.5	1 - 3 - 5	15	90	180

*Rack position from the bottom

- ① **Note:** Cooking times are approximate and may vary according to personal taste. When cooking using the grill or fan assisted grill, the dripping pan must always be placed on the 1st oven shelf from the bottom.

CLEANING & MAINTENANCE

- Before cleaning your oven or performing maintenance, make sure that the cooking mode selection knob is set to **off** and the cooking temperature selection knob is set to **off**. To extend the life of your oven, it must be cleaned frequently.
 - The enamelled or stainless steel parts should be washed with lukewarm water without using any abrasive powders or corrosive substances. If any stainless steel has difficulty to remove stains, use cleaners specifically recommended to clean stainless steel. After cleaning any surface, it is advisable to rinse thoroughly and dry.
 - The inside of the oven should preferably be cleaned immediately after use, when it is still warm (but not hot), with warm water and soap. The soap should be rinsed away and the interior dried thoroughly. Avoid using abrasive detergents, scourers acidic cleaners such as lime scale remover, etc. as these could damage the enamel. If stains are particularly tough to remove, use cleaners specifically recommended to clean ovens and follow the instructions provided with the cleaner.
- ① **Important!** Never use a steam cleaner or caustic oven cleaners for cleaning inside the oven.
- If you operate your oven for an extended period of time, or if you are cooking dishes that contain a lot of water, condensation may form on the oven door. Dry it using a soft cloth and try reducing the cooking temperature.
 - There is a seal surrounding the oven opening which is necessary to ensure the correct operation of the oven. Check the condition of this seal on a regular basis. If necessary, clean it but avoid using abrasive products or objects to do so. Should it become damaged, please contact Glen Dimplex Service Department. We recommend you avoid using the oven until it has been repaired.
- ① **Important!** Never place anything (including foil and oven trays) on the bottom of the oven when it is in operation because this could damage the enamel.
- Clean the glass door using non-abrasive products or sponges and dry it with a soft cloth.
- ① **Important!** Do not use harsh abrasive cleaners or sharp metal scrapers to clean the oven door glass since they can scratch the surface, which may result in shattering of the glass. Use only non caustic oven cleaners purchased from hardware stores or supermarkets.

CLEANING & MAINTENANCE

How to Remove the Oven Door

You can remove the oven door for better access to the oven when cleaning. Proceed as follows to remove the door:

- ① Open the door fully.
- ② Lift up and turn the latch **A** situated on each of the two hinges.
- ③ Grip the door on the two external sides and close it approximately 3/4 way.
- ④ Pull the door up towards you, lifting it out of the oven frame.
- ⑤ To replace the door, repeat the above steps in reverse order.

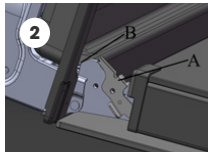

CLEANING & MAINTENANCE

How to Dismantle the Oven Door for Cleaning

You can remove the inner door glass for better cleaning. Proceed as follows to remove the inner door glass:

- ① Remove the cap on top of the door by unscrewing the 2 screws on the left and right sides.
- ② Gently slide out the inner pane of glass.
- ③ Clean the glass with an appropriate cleaner. Dry thoroughly and place on a soft surface.
- ④ Now you can also clean the inside of the outer glass.
- ⑤ Use the reverse procedure to re-assemble the door glass.

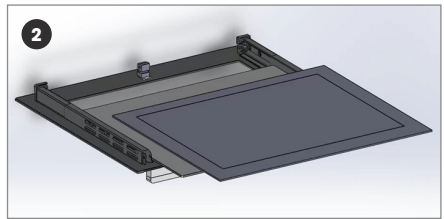
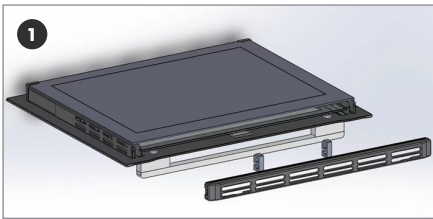

CLEANING & MAINTENANCE

Replacing the Oven Lamp

⚠ **Warning!** Ensure that the appliance is switched off before replacing the lamp to avoid the possibility of electric shock. Remove the glass cover of the lamp-holder.

Remove the lamp and replace with a lamp resistant to high temperatures (300°C) with the following characteristics:

- Voltage: 220-240V
- Wattage: 25W
- Type: G9

Replacement lamps are available from Glen Dimplex.

Replace the glass cover and reconnect the oven to the mains power supply.

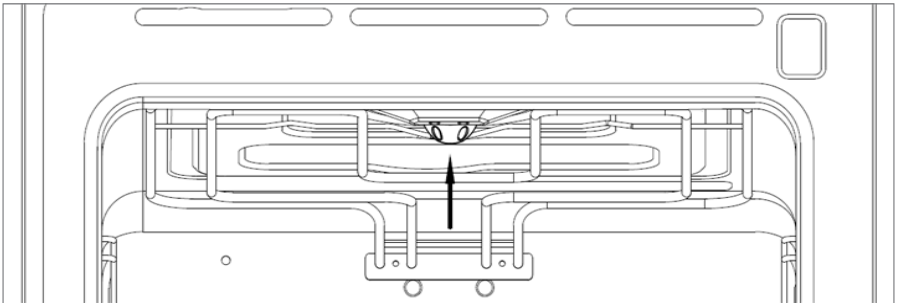

PRODUCT INFORMATION

Model number(s):	EO605MTS (Stainless steel)
Voltage & frequency:	220 - 240V ~ / 50 - 60Hz
Usable volume:	81L
Total volume:	92L
Output power:	1700 - 2000W
Net weight (kg):	32.0
Gross weight (kg):	36.5
Product dimensions (mm):	594 (w) x 595 (h) x 554 (d)
Cut-out dimensions (mm):	596 (w) x 596 (h) x 572 (d)

MANUFACTURER GUARANTEE

This warranty is provided in Australia by Glen Dimplex Australia Pty Limited ABN 69 118 275 460 (**Phone number 1300 556 816**) and in New Zealand by Glen Dimplex New Zealand Limited NZBN 9429000069823 (**Phone number 09 274 8265**) in respect of the Euromaid product.

1. Euromaid Express Warranty

Subject to the exclusions below, we warrant that the product will not have any electrical or mechanical breakdowns within:

- a In the case of **Euromaid** products used for personal, domestic or household purposes, a period of **2 years** from the date the product is purchased as a brand-new product from a retailer located in Australia / New Zealand.
 - b The warranty period may be extended by an additional **3 years** (5 years total) if the appliance is registered on the **Euromaid** website (listed below) within 90 days following the date of original purchase.
Australia: euromaid.com.au **New Zealand:** euromaid.co.nz
 - c In the case of **Euromaid** products used for purposes other than personal, domestic or household purposes (including business or commercial use), a period of 90 days from the date the product is purchased as a brand-new product from a retailer located in Australia / New Zealand. **Euromaid** products are designed and intended for domestic use only; and
 - d All warranty repairs must be carried out by Glen Dimplex or their nominated service agent.
- i **Note: warranty periods detailed above may vary in line with agreements with select retail and builder partners and may differ between Australia and New Zealand.**

The benefits conferred by this express warranty are in addition to the Consumer Guarantees referred to in section 3 and any other statutory rights you may have under the Australian / New Zealand Consumer Law and/or other applicable laws.

MANUFACTURER GUARANTEE

2. Warranty Exclusions

This express warranty does not apply where:

- Ⓐ The product has been installed, used or operated otherwise than in accordance with the product manual or other similar documentation provided to you with the product;
- Ⓑ The product requires repairs due to damage resulting from accident, misuse, incorrect installation, insect or vermin infestation, improper liquid spillage, cleaning or maintenance, unauthorised modification, use on an incorrect voltage, power surges and dips, voltage supply problems, tampering or unauthorised repairs by any persons, use of defective or incompatible accessories or exposure to abnormally corrosive conditions, events independent of human control which occurred after the goods left the control of Glen Dimplex;
- Ⓒ The repair relates to the replacement of consumable parts such as fuses and bulbs or any other parts of the product which require routine replacement;
- Ⓓ You are unable to provide us with reasonable proof of purchase for the product;
- Ⓔ The breakdown occurs after the expiry of the express warranty period set out in section 1 or;
- Ⓕ The product was not purchased in Australia / New Zealand as a brand-new product.

3. Consumer Guarantees

Our goods come with guarantees that cannot be excluded under the Australian / New Zealand Consumer Law. You are entitled to a replacement or refund for a major failure and for compensation for any other reasonably foreseeable loss or damage. You are also entitled to have the goods repaired or replaced if the goods fail to be of acceptable quality and the failure does not amount to a major failure.

MANUFACTURER GUARANTEE

4. How to Make a Claim

You may make a claim under this warranty through our website, contacting our customer care line or via email. Contact details for Glen Dimplex Australia and New Zealand can be found at the end of this document.

To make a valid claim under this warranty, you must:

- Ⓐ Lodge the claim with us as soon as possible and no later than 14 days after you first become aware of the breakdown;
- Ⓑ Provide us with the product serial number;
- Ⓒ Provide us with reasonable proof of purchase for the product. This can take the form of a store receipt, new home handover form or other payment receipt documentation; and
- Ⓓ If required by us, provide us (or any person nominated by us) with access to the premises at which the product is located at times nominated by us (so that we can inspect the product).

5. Warranty Claims

If you make a valid claim under this warranty and none of the exclusions set out in section 2 apply, we will, at our election, either repair the product or replace the product with a product of identical specification (or where the product is superseded or no longer in stock, with a product of as close a specification as possible).

Goods presented for repair may be replaced by refurbished goods of the same type rather than being repaired. Refurbished parts may be used to repair the goods. Products are designed and supplied for normal domestic use. We will not be liable to you under this warranty for business loss or damage of any kind whatsoever.

Contact our Customer Care Team

Glen Dimplex Australia Pty Ltd

Ph: 1300 556 816
customer.care.ha@glendimplex.com.au
www.glendimplex.com.au

Glen Dimplex New Zealand Ltd

Ph: 09 274 8265
nztechserv@glendimplex.co.nz
www.glendimplex.co.nz

NOTES

READ THE INSTRUCTION BOOKLET BEFORE INSTALLING & USING THE APPLIANCE.

The manufacturer will not be responsible for any damage to property or to persons caused by incorrect installation or improper use of the appliance. The manufacturer is not responsible for any inaccuracies, due to printing or transcription errors, contained in this manual. In addition, the appearance of the figures reported is also purely indicative.

The manufacturer reserves the right to make changes to its products when considered necessary and useful, without affecting the essential safety and operating characteristics. Glen Dimplex constantly seeks ways to improve the specifications and designs of their products. Whilst every effort is made to produce up to date literature, this document should not be regarded as an infallible guide. Actual product only should be used to derive cut out sizes.

All appliances must be installed by a qualified person/s with adherence to the relevant electrical, plumbing and building codes, with compliance being issued as required by state or national legislation.

Additionally, all upright cookers must have the anti-tilt device installed correctly in adherence to the relevant standards by a licenced installer.

For maximum effectiveness and efficiency all rangehoods should be installed with the use of ductwork, by a licenced installer with adherence to the relevant state and national building codes and regulations.

All Glen Dimplex appliances are for Domestic use only, and must be installed by a licence installer into Domestic Applications only, without exception and to the required Authorities guidelines. Any installation outside of this will **VOID** warranty. Alfresco areas are not a Domestic application.

Euromaid

Distributed by

Glen Dimplex Australia Pty Ltd

Ph: 1300 556 816
customer.care.ha@glendimplex.com.au
www.glendimplex.com.au

Glen Dimplex New Zealand Ltd

Ph: 09 274 8265
nztechserv@glendimplex.co.nz
www.glendimplex.co.nz

*For service advice, please contact the Customer Care Centre by phone or email above.
For full terms and conditions, or to register your product warranty, please visit our website.*

Euromaid

euromaid.com.au | euromaid.co.nz