

ETL1000FCW

10kg Top Loader Washing Machine

Euromaid



FEATURES	
Colour	White
Capacity	10kg
Max Spin Speed	700 RPM
No. Of Programs	7
Motor Type	Universal (AC)
Temperature Settings	Cold - Warm - Hot
Delay Start	1-24hrs
Program Selector	Button
Control Type	Button
Display Type	Red LED
Child Lock	Yes

WASH PROGRAMS	
Program 1	Mixed
Program 2	Daily
Program 3	Whites
Program 4	Delicate
Program 5	Sport
Program 6	Intense
Program 7	Rapid

AUXILIARY FUNCTIONS	
Function 1	Auto Wash
Function 2	Fast +
Function 3	Drum Clean

ETL1000FCW

10kg Top Loader Washing Machine

Euromaid

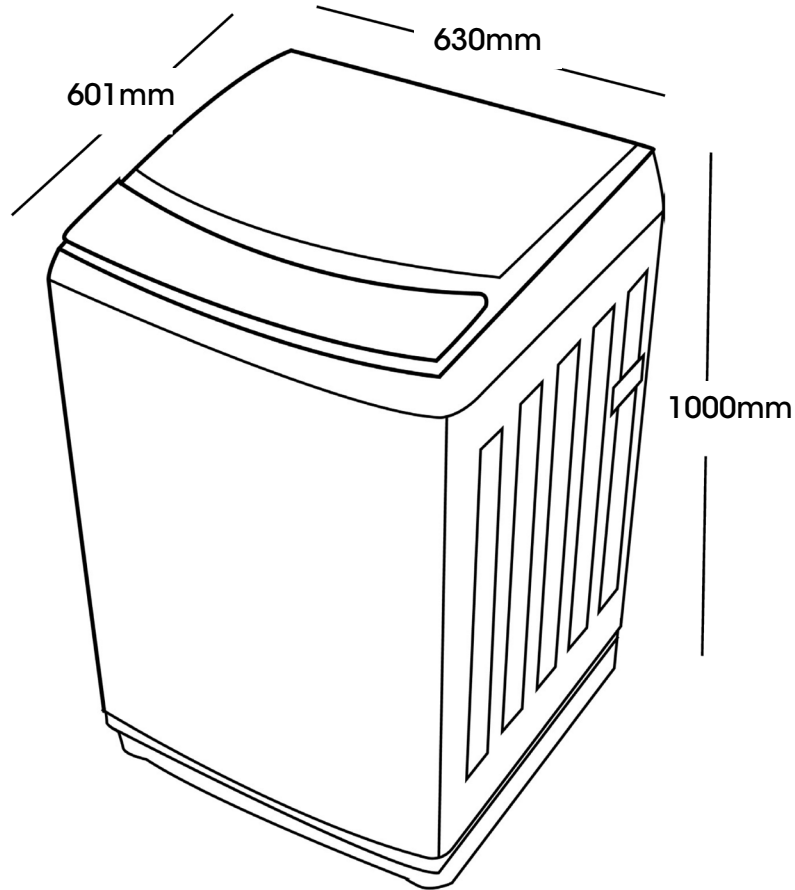

SPECIFICATIONS

Electrical Connection	10A Plug
Power	220 - 240V ~ 50Hz
Power Cord Length	1.8m
Inlet Hose Type	Hot & Cold
Inlet Hose Length	1m
Outlet Hose Length	1m
Energy Star Rating	2
kWh per year*	772
WELS Rating	3
Water Consumption**	136L

DIMENSIONS (W x D x H)

Product Boxed	685 x 660 x 1065mm
Product Un-boxed	630 x 601 x 1000mm

WEIGHT

Product Boxed	53kg
Product Un-boxed	45kg

WARRANTY

Product	2 Years Parts and Labour
---------	--------------------------



*Calculated based on the machine operating 7 times a week with the following parameters set: Daily program / Warm Water/ Water Level 8

**Calculated based on the machine operating with the following parameters set: Daily program / Warm Water/ Water Level 8

VERSION NO. 20210621