

# Euromaid

## User Manual

### 5.5kg Washing Machine WMFL55



# 1 General safety instructions

This section includes security instructions which may help prevent the injuries and material damage risks. All kinds of warranties shall be invalid if these instructions are not observed.

## 1.1 Life and property safety

- ▶ Never place the product on a carpet-covered floor. Electrical parts will get overheated since air cannot circulate from under the device. This will cause problems with your product.
- ▶ Unplug the product if it is not in use.
- ▶ Always have the installation and repairing procedures carried out by the Authorized Service Agent. Manufacturer shall not be held liable for damages that may arise from procedures carried out by unauthorized persons.
- ▶ The water supply and draining hoses must be securely fastened and remain undamaged. Otherwise, water leak may occur.
- ▶ While there is still water inside the product, never open the loading door or remove the filter. Otherwise, risk of flooding and injury from hot water will occur.
- ▶ Do not force open the locked loading door. Door can be opened a few minutes after the washing cycle ends. In case of forcing the loading door to open, the door and the lock mechanism may get damaged.
- ▶ Use detergents, softeners and supplements suitable for automatic washing machines only.
- ▶ Follow the instructions on the label of textiles and the detergent package.

## 1.2 Children's safety

- ▶ This product can be used by the children who are at the age of 8 and over and the people whose physical, sensory or mental skills are not fully developed or who do not have necessary required experience and knowledge as long as they are supervised or trained about the safe use of the product and its risks. Children should not play with the device. Cleaning and maintenance works should not be performed by children unless they are supervised by someone. Children of less than 3 years should be kept away unless continuously supervised.
- ▶ Packaging materials may be dangerous for the children. Keep packaging materials in a safe place away from reach of the children.
- ▶ Electrical products are dangerous for the children. Keep the children away from the product when it is in use. Do not allow them to play with the product. Use child lock to prevent children from intervening with the product.

- ▶ Do not forget to close the loading door when leaving the room where the product is located.
- ▶ store all detergents and additives in a safe place away from the reach of the children by closing the cover of the detergent container or sealing the detergent package.

### 1.3 Electrical safety

- ▶ If the product has a failure, it should not be operated unless it is repaired by the Authorized Service Agent. Risk of electric shock!
- ▶ This product is designed to resume operating in the event of powering on after a power interruption. If you wish to cancel the programme, see "Cancelling the programme" section.
- ▶ Plug the product into a grounded outlet protected by a 16 A fuse. Do not neglect to have the grounding installation made by a qualified electrician. Our company shall not be liable for any damages that will arise when the product is used without grounding in accordance with the local regulations.
- ▶ Do not wash the product by spraying or pouring water onto it! Risk of electric shock!
- ▶ Never touch the power cable plug with wet hands! Do not grab the power cord to unplug the machine, always unplug it by holding the socket with one hand, and pulling the plug with the other hand.
- ▶ Product should be unplugged during installation, maintenance, cleaning and repair procedures.
- ▶ If the power cable is damaged, it must be replaced by the manufacturer, after sales service or a similarly qualified person (preferably an electrician) or someone designated by the importer in order to avoid possible risks.

### 1.4 Hot surface safety



While washing the laundry at high temperatures, the loading door glass will get hot. Considering this fact, during washing operation keep the children away from the loading door of the product to prevent them touching it.

## 2 Important instructions for environment

### 2.1 Compliance with WEEE Directive

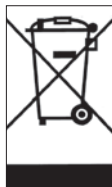

This product complies with EU WEEE Directive (2012/19/EU). This product bears a classification symbol for waste electrical and electronic equipment (WEEE).

This product has been manufactured with high quality parts and materials which can be reused and are suitable for recycling. Do not dispose of the waste product with normal domestic and other wastes at the end of its service life. Take it to the collection center for the recycling of electrical and electronic equipment. Please consult your local authorities to learn about these collection centers.

Compliance with RoHS Directive:

The product you have purchased complies with EU RoHS Directive (2011/65/EU). It does not contain harmful and prohibited materials specified in the Directive.

### 2.2 Package information

Packaging materials of the product are manufactured from recyclable materials in accordance with our National Environment Regulations. Do not dispose of the packaging materials together with the domestic or other wastes. Take them to the packaging material collection points designated by the local authorities.

## 3 Intended use

- This product has been designed for domestic use. It is not for commercial purposes or it should not be used out of its intended use.
- The product must only be used for washing and rinsing of laundry that are marked accordingly.
- The manufacturer waives any responsibility arisen from incorrect usage or transportation.
- The service life of your product is 10 years. During this period, original spare parts will be available to operate the appliance properly.

## 4 Technical specifications

Supplier name or trademark	EUROMAID
Model name	WMFL55
Rated capacity (kg)	5.5
Maximum spin speed (rpm)	1200
Built-in	No
Height (cm)	84
Width (cm)	60
Depth (cm)	48
Net weight ( $\pm 4$ kg.)	59
Single Water inlet / Double Water inlet	• / -
• Available	
Electrical input (V/Hz)	220-240 V / 50Hz
Total current (A)	10
Total power (W)	2000-2350
Main model code	929
Technical specifications may be changed without prior notice to improve the quality of the product.	

## 4.1 Installation

- Apply to the nearest authorized service agent for the installation of your product.
- Preparation of the location and electrical, tap water and waste water installations at the place of installation is under customer's responsibility.
- Make sure that the water inlet and discharge hoses as well as the power cable are not folded, pinched or crushed while pushing the product into its place after installation or cleaning procedures.
- Make sure that the installation and electrical connections of the product are performed by authorized service. Manufacturer shall not be held liable for damages that may arise from procedures carried out by unauthorized persons.
- Prior to installation, visually check if the product has any defects on it. If so, do not have it installed. Damaged products cause risks for your safety.

### 4.1.1 Appropriate installation location

- Place the product on a hard and level floor. Do not put it onto a carpet with high pile or other similar surfaces.
- When the washing machine and dryer are placed on top of each other, their total weight –when loaded– amounts to 180 kilograms. Place the product on a solid and flat floor that has sufficient load carrying capacity!
- Do not place the product on the power cable.
- Do not install the product in the environments where the temperature falls below 0 °C.
- Leave a minimum space of 1 cm between the machine and the furniture.
- On a graduated floor, do not place the product next to the edge or on a platform.
- Do not place heat sources such as Hobs, Irons, Ovens, etc. on the washing machine and do not use them on the product.

### 4.1.2 Removing packaging reinforcement



Tilt the machine backwards to remove the packaging reinforcement. Remove the packaging reinforcement by pulling the ribbon. Do not make this operation alone by yourself.

### 4.1.3 Removing the transportation locks

- 1 Loosen all bolts with an appropriate wrench until they turn freely.
- 2 Remove the transport safety bolts by turning them slightly.
- 3 Insert the plastic covers in the bag containing the user manual to the openings on the rear panel.

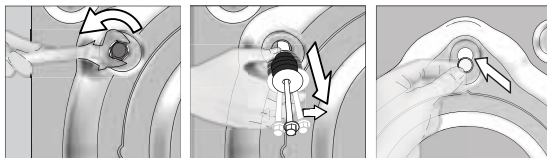

**CAUTION:** Remove the transportation safety bolts before operating the washing machine! Otherwise, the product will be damaged.



Keep the transportation safety bolts in a safe place to reuse when the washing machine needs to be moved again in the future.

Install the transport safety bolts in reverse order of the disassembly procedure.

Never move the product without the transportation safety bolts properly fixed in place!

## 4.1.4 Connecting water supply



The water supply pressure required to run the product is between 1 to 10 bars (0.1 – 1 MPa). It is necessary to have 10 – 80 liters of water flowing from the fully open tap in one minute to have your machine run smoothly. Attach a pressure reducing valve if water pressure is higher.



**CAUTION:** Models with a single water inlet should not be connected to the hot water tap. In such a case the laundry will get damaged or the product will switch to protection mode and will not operate.

**CAUTION:** Do not use old or used water inlet hoses on the new product. It may cause stains on your laundry.

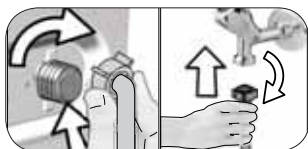

- 1 Tighten the nuts of the hose by hand. Never use a tool when tightening the nuts.
- 2 When hose connection is completed, check whether there is leak problems at the connection points by opening the taps fully. If any leaks occur, turn off the tap and remove the nut. Retighten the nut carefully after checking the seal. In order to prevent the water leaks and resultant damages, keep the taps closed when you do not use the product.

## 4.1.5 Connecting the drain hose to the drain

- Attach the end of the drain hose directly to waste water drain, lavatory or bathtub.



**CAUTION:** Your drain house will be flooded if the hose comes out of its housing during water discharge. Moreover, there is risk of scalding due to high washing temperatures! In order to prevent such situations and make sure that the machine performs water intake and discharge processes without any problem, fix the drain hose securely.

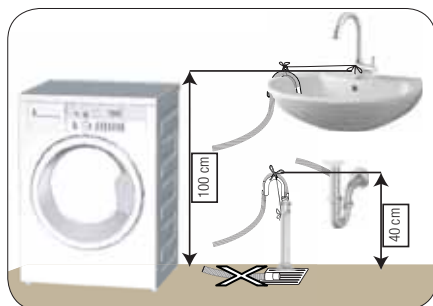

- Connect the drain hose to a minimum height of 40 cm and a maximum height of 100 cm.
- In case the drain hose is elevated after laying it on the floor level or close to the ground (less than 40 cm above the ground), water discharge becomes more difficult and the laundry may come out excessively wet. Therefore, follow the heights described in the figure.

- To prevent the waste water to go back into the machine again and to ensure easy drainage, do not immerse the end of the hose into the waste water or do not insert it into the drain for more than 15 cm. If it is too long, cut it short.
- The end of the hose should not be bent, it should not be stepped on and the hose must not be pinched between the drain and the machine.
- If the length of the hose is too short, use it by adding an original extension hose. Length of the hose may not be longer than 3.2 m. To avoid water leak failures, the connection between the extension hose and the drain hose of the product must be fitted well with an appropriate clamp as not to come off and leak.

## 4.1.6 Adjusting the feet



**CAUTION:** In order to ensure that the product operates more silently and vibration-free, it must stand level and balanced on its feet. Balance the machine by adjusting the feet. Otherwise, the product may move from its place and cause crushing and vibration problems.

**CAUTION:** Do not use any tools to loosen the lock nuts. Otherwise, they will get damaged.

- 1 Loosen the lock nuts on the feet by hand.
- 2 Adjust the feet until the product stands in a stable and balanced way.
3. Tighten all lock nuts by hand again.

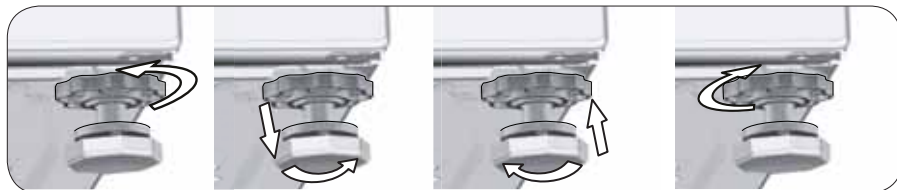

## 4.1.7 Electrical connection

Connect the product to a grounded outlet protected by a 16 A fuse. Our company shall not be liable for any damages that will arise when the product is used without grounding in accordance with the local regulations.

- Connection must comply with national regulations.
- The wiring for the electrical outlet circuit must be sufficient to meet the appliance requirements. Use of a Ground Fault Circuit Interrupter (GFCI) is recommended.
- Power cable plug must be within easy reach after installation.
- If the current value of the fuse or breaker in the house is less than 16 Amps, have a qualified electrician install a 16 Amp fuse.
- The voltage specified in the "Technical specifications" section must be equal to your mains voltage.
- Do not make connections via extension cables or multi-plugs.



**CAUTION:** Damaged power cables must be replaced by the Authorized Service Agents.

## 4.1.8 Initial use



Before starting to use the product make sure that the preparations are made which are in line with the "Important Safety and Environment Instructions" and the instructions in the "Installation" section.

To prepare the product for washing laundry, perform first operation in Drum Cleaning programme. If this program is not available in your machine, apply the method which is described in the section 4.4.2.



Use an anti-limescale suitable for the washing machines.

Some water might have remained in the product due to the quality control processes in the production. It is not harmful for the product.



## 4.2 Preparation

### 4.2.1 Sorting the laundry

- \* Sort laundry according to type of fabric, color, and degree of soiling and allowable water temperature.
- \* Always obey the instructions given on the garment tags.

### 4.2.2 Preparing laundry for washing

- Laundry items with metal attachments such as, underwired bras, belt buckles or metal buttons will damage the machine. Remove the metal pieces or wash the clothes by putting them in a laundry bag or pillow case.
- Take out all substances in the pockets such as coins, pens and paper clips, and turn pockets inside out and brush. Such objects may damage the product or cause noise problem.
- Put small size clothes such as infant's socks and nylon stockings in a laundry bag or pillow case.
- Place curtains in without compressing them. Remove curtain attachment items.
- Fasten zippers, sew loose buttons and mend rips and tears.
- Wash "machine washable" or "hand washable" labeled products only with an appropriate programme.
- Do not wash colours and whites together. New, dark coloured cottons release a lot of dye. Wash them separately.
- Tough stains must be treated properly before washing. If unsure, check with a dry cleaner.
- Only use the dyes / color changers and descaling agents which are appropriate to machine wash. Always follow the instructions on the package.
- Wash trousers and delicate laundry turned inside out.
- Keep laundry items made of Angora wool in the freezer for a few hours before washing. This will reduce pilling.
- Laundry that are subjected to materials such as flour, lime dust, milk powder, etc. intensely must be shaken off before placing into the machine. Such dusts and powders on the laundry may build up on the inner parts of the machine in time and can cause damage.

### 4.2.3 Things to be done for energy saving

Following information will help you use the product in an ecological and energy-efficient manner.

- Operate the product in the highest capacity allowed by the programme you have selected, but do not overload; see, "Programme and consumption table". See, "Programme and consumption table"
- Always follow the instructions on the detergent packaging.
- Wash slightly soiled laundry at low temperatures.
- Use faster programmes for small quantities of lightly soiled laundry.
- Do not use prewash and high temperatures for laundry that is not heavily soiled or stained.
- If you plan to dry your laundry in a dryer, select the highest spin speed recommended during washing process.
- Do not use more detergent than the recommended amount specified on its package.

### 4.2.4 Loading the laundry

1. Open the laundry cover.
2. Put the laundry items into the machine in a loose manner.
3. Push and close the loading cover until you hear the locking sound. Ensure that no items are caught in the door. The loading door is locked while a programme is running. The door can only be opened a while after the programme comes to an end.

### 4.2.5 Correct load capacity

The maximum load capacity depends on the type of laundry, the degree of soiling and the washing programme desired.

Machine automatically adjusts the water amount according to the weight of the laundry put inside it.



**WARNING:** Follow the information in the "Programme and consumption table". When overloaded, machine's washing performance will drop. Moreover, noise and vibration problems may occur.

## 4.2.6 Using detergent and softener



When using detergent, softener, starch, fabric dye, bleach and decolorant, descaling agents; read the manufacturer's instructions written on the package and follow the dosages specified. Use measuring cup if available.

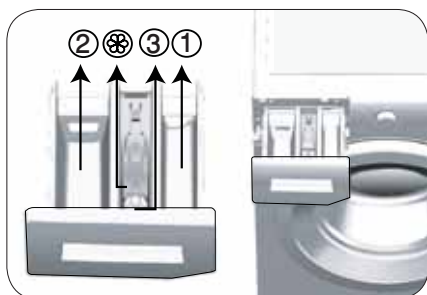

The detergent drawer is composed of three compartments:

- (1) for prewash
- (2) for main wash
- (3) for softener
- (☼) in addition, there is a siphon piece in the softener compartment.

### Detergent, softener and other cleaning agents

- Add detergent and softener before starting the washing programme.
  - While the washing cycle is in progress, do not leave the detergent dispenser open!
  - When using a programme without prewash, do not put any detergent into the prewash compartment (compartment nr. "1").
  - In a programme with prewash, do not put liquid detergent into the prewash compartment (compartment nr. "1").
  - Do not select a programme with prewash if you are using a detergent bag or dispensing ball. Place the detergent bag or the dispensing ball directly among the laundry in the machine.
- If you are using liquid detergent, do not forget to place the liquid detergent container into the main wash compartment (compartment number "2").

### Choosing the detergent type

Detergent type to be used depends on the fabric type and color.

- Use different detergents for coloured and white laundry.
- Wash your delicate clothes only with special detergents (liquid detergent, wool shampoo, etc.) used solely for delicate clothes.
- When washing dark coloured clothes and quilts, it is recommended to use liquid detergent.
- Wash woolens with special detergent made specifically for woolens.



**CAUTION:** Use only detergents manufactured specifically for washing machines.

**CAUTION:** Do not use soap powder.

### Adjusting detergent amount

The amount of washing detergent to be used depends on the amount of laundry, the degree of soiling and water hardness.

- Do not use amounts exceeding the dosage quantities recommended on the detergent package to avoid problems of excessive foam, poor rinsing, financial savings and finally, environmental protection.
- Use lesser detergent for small amounts or lightly soiled clothes.

### Using softeners

Pour the softener into the softener compartment of the detergent drawer.

- Do not exceed the (>max<) level sign on the softener compartment.
- If the softener has lost its fluidity, dilute it with water before putting it in the detergent drawer.

## Using liquid detergents

### If the product contains a liquid detergent cup:

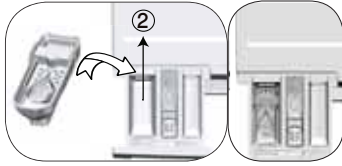

- Put the liquid detergent container into the compartment no "2".
- If the liquid detergent lost its fluidity, dilute it with water before putting it into the detergent container.

### If the product does not contain a liquid detergent cup:

- Do not use liquid detergent for the prewash in a programme with prewash.
- Liquid detergent stains your clothes when used with Delayed Start function. If you are going to use the Delayed Start function, do not use liquid detergent.

### Using gel and tablet detergent

- If the gel detergent thickness is fluidal and your machine does not contain a special liquid detergent cup, put the gel detergent into the main wash detergent compartment during first water intake. If your machine contains a liquid detergent cup, fill the detergent into this cup before starting the programme.
- If the gel detergent thickness is not fluidal or in the shape of capsule liquid tablet, put it directly into the drum before washing.
- Put tablet detergents into the main wash compartment (compartment nr. "2") or directly into the drum before washing.

### Using starch

- Put the liquid soda, powder soda or the fabric dye into the softener compartment.  
Do not use softener and starch together in a washing cycle.  
Wipe the inside of the machine with a damp and clean cloth after using starch.

### Using limescale remover

- When required, use limescale removers manufactured specifically for washing machines only.

### Using bleaches

Add the bleach at the beginning of the washing cycle by selecting a prewash program. Do not put detergent in the prewash compartment. As an alternative application, select a programme with extra rinse and add the bleaching agent while the machine is taking water from the detergent compartment during first rinsing step.

- Do not use bleaching agent and detergent by mixing them.
- Use just a little amount (approx. 50 ml) of bleaching agent and rinse the clothes very well as it causes skin irritation. Do not pour the bleach onto the laundry and do not use it with the colored items.
- When using oxygen-based decolorant, select a program which washes the laundry at a low temperature.
- Oxygen-based decolorant can be used with the detergent; however, if it is not at the same consistence, first put detergent in the compartment number "2" in the detergent dispenser and wait for the machine to flush the detergent when taking in water. While the machine continues taking in water, add decolorant in the same compartment.

## 4.2.7 Tips for efficient washing

		Clothes			
		Light Colours and Whites	Colours	Black/Dark Colours	Delicates/Woolens/Silks
		(Recommended temperature range based on soiling level: 40-90 °C)	(Recommended temperature range based on soiling level: cold -40 °C)	(Recommended temperature range based on soiling level: cold -40 °C)	(Recommended temperature range based on soiling level: cold -30 °C)
<b>Soiling Level</b>	<b>Heavily Soiled</b> (difficult stains such as grass, coffee, fruits and blood.)	It may be necessary to pre-treat the stains or perform prewash. Powder and liquid detergents recommended for whites can be used at dosages recommended for heavily soiled clothes. It is recommended to use powder detergents to clean clay and soil stains and the stains that are sensitive to bleaches.	Powder and liquid detergents recommended for colors can be used at dosages recommended for heavily soiled clothes. It is recommended to use powder detergents to clean clay and soil stains and the stains that are sensitive to bleaches. Use detergents without bleach.	Liquid detergents suitable for colors and dark colors can be used at dosages recommended for heavily soiled clothes.	Prefer liquid detergents produced for delicate clothes. Woolen and silk clothes must be washed with special woolen detergents.
	<b>Normally Soiled</b> (For example, stains caused by body on collars and cuffs)	Powder and liquid detergents recommended for whites can be used at dosages recommended for normally soiled clothes.	Powder and liquid detergents recommended for colors can be used at dosages recommended for normally soiled clothes. Detergents which do not contain bleach should be used.	Liquid detergents suitable for colors and dark colors can be used at dosages recommended for normally soiled clothes.	Prefer liquid detergents produced for delicate clothes. Woolen and silk clothes must be washed with special woolen detergents.
	<b>Lightly Soiled</b> (No visible stains exist.)	Powder and liquid detergents recommended for whites can be used at dosages recommended for lightly soiled clothes.	Powder and liquid detergents recommended for colors can be used at dosages recommended for lightly soiled clothes. Detergents which do not contain bleach should be used.	Liquid detergents suitable for colors and dark colors can be used at dosages recommended for lightly soiled clothes.	Prefer liquid detergents produced for delicate clothes. Woolen and silk clothes must be washed with special woolen detergents.

## 4.3 Operating the product

### 4.3.1 Control panel

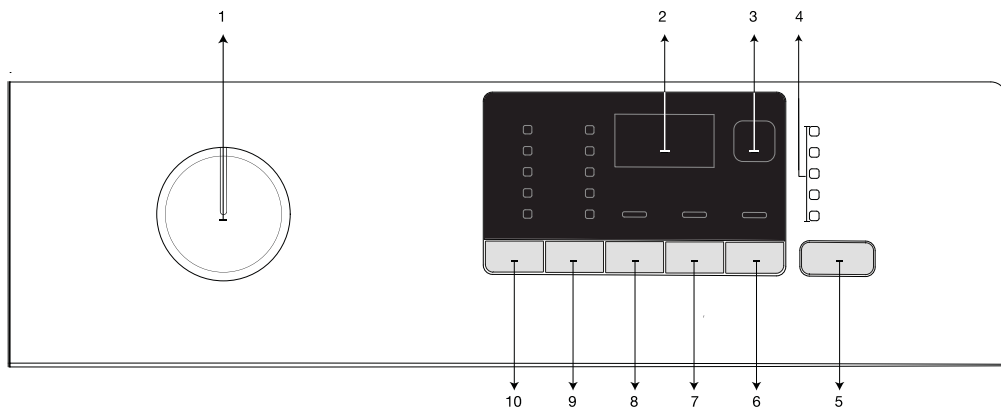

- 1 - Programme Selection knob (Uppermost position On / Off)
- 2 - Display
- 3 - Delayed Start Indicator
- 4 - Programme Follow-up indicator
- 5 - Start / Pause button

- 6 - Auxiliary function button 3
- 7 - Auxiliary function button 2
- 8 - Auxiliary function button 1
- 9 - Spin Speed Adjustment button
- 10 - Temperature Adjustment button

### 4.3.2 Preparing the machine

1. Make sure that the hoses are connected tightly.
2. Plug in your machine.
3. Turn the tap on completely.
4. Place the laundry in the machine.
5. Add detergent and fabric softener.

### 4.3.3 Programme selection and tips for efficient washing

1. Select the programme suitable for the type, quantity and soiling degree of the laundry in accordance with the "Programme and consumption table" and the temperature table below.
2. Select the desired programme with the Programme Selection knob.

Indicative values for Synthetics programmes (EN)						
	Load (kg)	Water Consumption (l)	Energy Consumption (kWh)	Programme Duration (min) *	Remaining Moisture Content (%) ** ≤ 1000 rpm	Remaining Moisture Content (%) ** > 1000 rpm
Easy Care 60	4	70	1.40	115/150	45	40
Easy Care 40	4	70	0.95	115/150	45	40

\* You can see the washing time of the programme you have selected on the display of the machine. It is normal that small differences may occur between the time shown on the display and the real washing time.

\*\* Remaining moisture content values may differ according to the selected spin speed.

### 4.3.4 Programme and consumption table

EN						Auxiliary functions			
Program		Max. Load (kg)	Water Consumption (l)	Energy Consumption (kWh)	Max. Speed***	Prewash	Quick Wash	Rinse Plus	Selectable temperature range °C
Cottons	90	5.5	85	2.00	1600	•	•	•	Cold - 90
	60	5.5	85	1.60	1600	•	•	•	Cold - 90
	40	5.5	80	0.90	1600	•	•	•	Cold - 90
Cottons Eco	40**	5.5	65	1.30	1600				Cold - 40
Synthetics	60	2.5	62	1.15	1200	•	•	•	Cold - 60
	40	2.5	60	0.75	1200	•	•	•	Cold - 60
Mini/Mini14 + Quick Wash	90	2	45	1.65	1400		•	•	Cold - 90
Mini/Mini14	90	5.5	60	1.75	1400		•	•	Cold - 90
	60	5.5	58	1.20	1400		•	•	Cold - 90
	30	5.5	58	0.50	1400		•	•	Cold - 90
Mix 40	40	3	55	0.55	800	•	•		Cold - 40
Wool/HandWash	40	1.5	55	0.55	1200			•	Cold- 40
Delicate	40	2.5	45	0.55	1200			•	Cold- 40
Down Wear	60	1.5	75	0.55	1000			•	Cold - 60
Outdoor/Sports (Goralex)	40	2.5	40	0.45	1200	•			Cold - 40
Darkwash/Jeans	40	2	80	0.70	1200	•		*	Cold - 40
Lingerie	30	1	65	0.35	600			*	Cold - 30
Shirts	60	2.5	60	1.10	800	•	•	•	Cold - 60
Hygiene	90	5.5	110	2.10	1600			*	20-90
Drum Cleaning	90	-	65	1.85	600				90





• : Selectable

\* : Automatically selected, no canceling.

\*\* : Energy Label programme (EN 60456 Ed.3)

\*\*\*: If maximum spin speed of the machine is lower then this value, you can only select up to the maximum spin speed.

- : See the programme description for maximum load.

	** "Cotton Economic 40°C and Cotton Economic 60°C are standard programmes." These programmes are known as '40°C cotton standard programme' and '60°C cotton standard programme' and indicated with the   symbols on the panel.
	Water and power consumption may vary subject to the changes in water pressure, water hardness and temperature, ambient temperature, type and amount of laundry, selection of auxiliary functions and spin speed, and changes in electric voltage.
	You can see the washing duration on the display of your machine while selecting a programme. Depending on the amount of laundry you have loaded into your machine, there may be a difference of 1-1.5 hours between the duration shown on the display and the actual duration of the wash cycle. Duration will be automatically updated soon after the washing starts.
	The auxiliary functions in the table may vary according to the model of your machine.

### 4.3.5 Main programmes

Depending on the type of fabric, use the following main programmes.

- **Cottons**

You can wash your durable cotton laundry (sheets, bedlinen, towels, bathrobes, underwear etc.) in this programme. When the quick wash function button is pressed, programme duration becomes notably shorter but effective washing performance is ensured with intense washing movements. If the quick wash function is not selected, superior washing and rinsing performance is ensured for your heavily soiled laundry.

- **Easy Care**

You can wash your laundry (such as shirts, blouses, synthetic/cotton blended fabrics etc.) in this programme. The programme duration gets notable shorter and washing with high performance is ensured. If the quick wash function is not selected, superior washing and rinsing performance is ensured for your heavily soiled laundry.

- **Woolens / Hand Wash**

Use to wash your woolen/delicate laundry. Select the appropriate temperature complying with the tag of your clothes. Your laundry will be washed with a very gentle washing action in order not to damage the clothes.

### 4.3.6 Additional programmes

For special cases, additional programmes are available in the machine.



Additional programmes may differ according to the model of the machine.

- **Cottons Eco**

Use to wash your normally soiled, durable cotton and linen laundry. Although it washes longer than all other programmes, it provides high energy and water savings. Actual water temperature may be different from the stated wash temperature. When you load the machine with less laundry (e.g. ½ capacity or less), periods in programme stages may automatically get shorter. In this case, energy and water consumption will decrease more, providing a more economic wash.

- **Allergy**

This is a long-duration programme that you can use for your laundry requiring a hygienic washing at high temperatures with intensive and long washing cycle. The high level of hygiene is ensured thanks to long heating duration and additional rinsing step.

- **Delicates**

You can wash your delicate clothes such as cotton/synthetic blended knitwear or hosiery in this programme. It washes with more delicate washing action. Wash your clothes whose colour you want to preserve either at 20degrees or by selecting the cold wash option.

- **Daily Xpress / Super Short 14'**

Use this programme to wash your lightly soiled or unspotted cotton clothes in a short time. The programme duration can be reduced up to 14 minutes when the quick wash function is selected. When the quick wash function is selected, maximum 2 (two) kg of laundry must be washed.

- **Dark Wash**

Use this programme to protect the colour of your dark-coloured garments or jeans. It performs high performance washing with special drum movement even if the temperature is low. It is recommended to use liquid detergent or woolen shampoo for dark coloured laundry. Do not wash your delicate clothes containing wool or etc.

- **Mixed**

Use to wash your cotton and synthetic clothes together without sorting them.

### • Shirts

This programme is used to wash the shirts made from cotton, synthetic and synthetic blended fabrics altogether. It reduces wrinkles. When the quick wash function is selected, the Pre-treatment algorithm is executed.

- Apply the pre-treatment chemical on your garments directly or add it together with detergent when the machine starts to take water from the main washing compartment. Thus, you can obtain the same performance as you obtain with normal washing in a much shorter period of time. Usage life of your shirts increases.

### • Sports

You can use this programme to wash sports and outdoors garments that contain cotton/synthetics mix and water repellent covers such as gore-tex etc. It makes sure your garments are washed gently thanks to special rotating movements.

### • Lingerie

You can use this programme to wash delicate garments that are suitable for hand wash and delicate women's underwear. Small amount of garments must be washed in a washing net. Hooks, buttons etc. must be done up and zips must be zipped up.

### • Duvet

Use this programme to wash your fiber duvets that bear "machine washable" tag. Check that you have loaded the duvet correctly in order not to damage the machine and the duvet. Remove the duvet cover before loading the duvet into the machine. Fold the duvet into two and load it into the machine. Load the duvet into the machine paying attention to place it in a way that it will not contact the bellow or the glass.



Do not load more than 1 double fiber duvet (200 x 200 cm).

Do not wash your duvets, pillows and etc. that contain cotton in the machine.



**CAUTION:** Do not wash the items apart from duvets such as carpets, rugs and etc. in the machine. Permanent damage occurs in the machine.

## 4.3.7 Special programmes

For specific applications, select any of the following programmes.

### • Rinse

Use when you want to rinse or starch separately.

### • Spin+Drain

You can use this function to remove the water on the garment or drain the water in the machine.

Before selecting this programme, select the desired spin speed and press Start / Pause button. First, the machine will drain the water inside of it. Then, it will spin the laundry with the set spin speed and drain the water coming out of them.

If you wish to drain only the water without spinning your laundry, select the Pump+Spin programme and then select the No Spin function with the help of Spin Speed Adjustment button. Press Start / Pause button.



Use a lower spin speed for delicate laundries.

## 4.3.8 Temperature selection

Whenever a new programme is selected, the recommended temperature value for the selected programme appears on the temperature indicator.

To decrease the temperature, press the Temperature Adjustment button. Temperature will decrease gradually. Temperature level lights will not turn on when the cold level is selected.



If the programme has not reached the heating step, you can change the temperature without switching the machine to Pause mode.



### 4.3.9 Spin speed selection

Whenever a new programme is selected, the recommended spin speed of the selected programme is displayed on the spin speed indicator.

To decrease the spin speed, press the Spin Speed Adjustment button. Spin speed decreases gradually. Then, depending on the model of the product, "Rinse Hold" and "No Spin" options appear on the display. When "No Spin" is selected, the rinse level indicator lights will not turn on.

#### Rinse hold

If you are not going to unload your clothes immediately after the programme completes, you can use rinse hold function to keep your laundry in the final rinsing water in order to prevent them from getting wrinkled when there is no water in the machine. Press Start / Pause button after this process if you want to drain the water without spinning your laundry. Programme will resume and complete after draining the water. If you want to spin the laundry held in water, adjust the Spin Speed and press Start / Pause button. The programme will resume. Water is drained, laundry is spun and the programme is completed.



If the programme has not reached the spinning step, you can change the speed without switching the machine to Pause mode.

### 4.3.10 Auxiliary function selection

Select the desired auxiliary functions before starting the programme. Furthermore, you may also select or cancel auxiliary functions that are suitable to the running programme without pressing the Start / Pause button when the machine is operating. For this, the machine must be in a step before the auxiliary function you are going to select or cancel.

If the auxiliary function cannot be selected or canceled, light of the relevant auxiliary function will blink 3 times to warn the user.



If a second auxiliary function conflicting with the first one is selected before starting the machine, the function selected first will be canceled and the second auxiliary function selection will remain active.

An auxiliary function that is not compatible with the programme cannot be selected. (See, "Programme and consumption table")

Auxiliary Function buttons may vary according to the model of the machine.

### 4.3.10.1 Auxiliary functions

#### • Prewash

A Prewash is only worthwhile for heavily soiled laundry. Not using the Prewash will save energy, water, detergent and time.



Prewash without detergent is recommended for tulle and curtains.

#### • Quick Wash

When this function is selected, the durations of the relevant programmes get shorter by 50%. Thanks to the optimised washing steps, high mechanic activity and optimum water consumption, high washing performance is achieved in spite of the reduced duration.



When you select this function, load your machine with half of the maximum laundry specified in the programme table.

#### • Extra Rinse

This function enables the product to make another rinsing in addition to the one already made after the main wash. Thus, the risk for sensitive skins (babies, allergic skins, etc.) to be effected by the minimal detergent remnants on the laundry can be reduced.

### 4.3.10.2 Functions/Programmes Selected by Pressing the Function Buttons for 3 Seconds

#### • Drum Cleaning

Press and hold the auxiliary function button 1 for 3 seconds to select the programme.

Use regularly (once in every 1-2 months) to clean the drum and provide the required hygiene. Operate the programme while the machine is completely empty. To obtain better results, put powder lime-scale remover for washing machines into the detergent compartment no. "2". When the programme is over, leave the loading door ajar so that the inside of the machine gets dry.



This is not a washing programme. It is a maintenance programme.

Do not run the programme when there is something in the machine. If you try to do so, the machine detects that there is load inside and aborts the programme.

#### • Child lock

Use Child Lock function to prevent children from tampering with the machine. Thus you can avoid any changes in a running programme.



If the Programme Selection knob is turned when the Child Lock is active, "Con" appears on the display. The Child Lock does not allow any change in the programmes and the selected temperature, speed and auxiliary functions.

Even if another programme is selected with the Programme Selection knob while the Child Lock is active, previously selected programme will continue running.

#### To activate the Child Lock:

2. Press and hold the Auxiliary Function button for 3 seconds. C03, C02, C01 will appear on the display respectively while you keep the button pressed for 3 seconds. Then, while the light of the Auxiliary Function button 2 is flashing, "Con" will appear on the display indicating that the child lock has been activated. If you press any button or turn the Programme Selection knob when the Child Lock is active, same phrase will appear on the display.

#### To deactivate the Child Lock:

Press and hold the Auxiliary Function button 2 for 3 seconds while a programme is running. C03, C02, C01 will appear on the display respectively while you keep the button pressed for 3 seconds. Then, while the light of the auxiliary function button 2 is flashing, "COF" will appear on the display indicating that the child lock has been deactivated.



In addition to the method above, to deactivate the Child Lock, switch the Programme Selection knob to On / Off position when no programme is running, and select another programme.

Child Lock is not deactivated after power failures or when the machine is unplugged.

### 4.3.11 Delayed Start

With the Delayed Start function the startup of the programme may be delayed up to 19 hours. Delayed start time can be increased by increments of 1 hour.



Do not use liquid detergents when you set Delayed Start! There is the risk of staining of the clothes.

1. Open the loading door, place the laundry and put detergent, etc.
2. Select the washing programme, temperature, spin speed and, if required, the auxiliary functions.
3. Set the desired time by pressing the Delayed Start button.
4. Press Start / Pause button. The delayed start time you have set is displayed. Delayed start countdown starts. " \_ " symbol next to the delayed start time moves up and down on the display.



Additional laundry may be loaded during the delayed start period.

5. At the end of the countdown, duration of the selected programme will be displayed. " \_ " will disappear and the selected programme will start.

### Changing the delayed start period

If you want to change the time during countdown:

1. Press the Delayed Start button. Time will increase by 1 hour each time you press the button.
2. If you want to decrease the delayed start time, press Delayed Start button repeatedly until the desired delayed start time appears on the display.

### Canceling the Delayed Start function

If you want to cancel the delayed start countdown and start the programme immediately:

1. Set the Delayed Start period to zero or turn the Programme Selection knob to any programme. Thus, Delayed Start function will be canceled. The End/Cancel light flashes continuously.
2. Then, select the programme you want to run again.
3. Press Start / Pause button to start the programme.

### 4.3.12 Starting the programme

1. Press Start / Pause button to start the programme.
2. Programme follow-up light showing the startup of the programme will turn on.



If no programme is started or no button is pressed within 1 minute during programme selection process, the machine will switch to Pause mode and the illumination level of the temperature, speed and loading door indicator lights will decrease. Other indicator lights and indicators will turn off. Once the Programme Selection knob is rotated or any button is pressed, indicator lights and indicators will turn on again.

### 4.3.13 Progress of programme

Progress of a running programme can be followed from the Programme Follow-up indicator. At the beginning of every programme step, the relevant indicator light will turn on and light of the completed step will turn off. You can change the auxiliary functions, speed and temperature settings without stopping the programme flow while the programme is running. To do this, the change you are going to make must be in a step after the running programme step. If the change is not compatible, relevant lights will flash for 3 times.



If the machine does not pass to the spinning step, Rinse Hold function might be active or the automatic unbalanced load detection system might be activated due to the unbalanced distribution of the laundry in the machine.

### 4.3.14 Loading door lock

There is a locking system on the loading door of the machine that prevents opening of the loading door in cases when the water level is unsuitable.

Loading door light will start flashing when the machine is switched to Pause mode. Machine checks the level of the water inside. If the level is suitable, Loading Door light illuminates steadily within 1-2 minutes and the loading door can be opened.

If the level is unsuitable, Loading Door light turns off and the loading door cannot be opened. If you are obliged to open the Loading Door while the Loading Door light is off, you must cancel the current programme. See. "Cancelling the programme"

### 4.3.15 Changing the selections after programme has started

#### Switching the machine to pause mode

Press the Start / Pause button to switch the machine to pause mode while a programme is running. The light of the step which the machine is in starts flashing in the Programme Follow-up indicator to show that the machine has been switched to the pause mode.

Also, when the loading door is ready to be opened, Loading Door light will also illuminate continuously in addition to the programme step light.

### Changing the auxiliary function, speed and temperature

Depending on the step the programme has reached, you can cancel or select the auxiliary functions. See, "Auxiliary function selection".

You can also change the speed and temperature settings. See, "Spin speed selection" and "Temperature selection".



If no change is allowed, the relevant light will flash 3 times.

### Adding or taking out laundry

1. Press Start / Pause button to switch the machine to pause mode. The programme follow-up light of the relevant step during which the machine was switched into the pause mode will flash.
2. Wait until the Loading Door can be opened.
3. Open the Loading Door and add or take out the laundry.
4. Close the Loading Door.
5. Make changes in auxiliary functions, temperature and speed settings if necessary.
6. Press Start / Pause button to start the machine.

### 4.3.16 Cancelling the programme

To cancel the programme, turn the Programme Selection knob to select another programme. Previous programme will be cancelled. End / Cancel light will flash continuously to notify that the programme has been canceled.

Your machine will end the programme when you turn the Programme Selection knob; however, it does not drain the water inside. When you select and start a new programme, the newly selected programme will start depending on the step the previous programme was canceled in. For example, it may take in additional water or continue to wash with the water inside.



Depending on the step where the programme was canceled in, you may have to put detergent and softener again for the programme you have selected anew.

### 4.3.17 End of programme

"End" appears on the display at the end of the programme.

1. Wait until the loading door light illuminates steadily.
2. Press On / Off button to switch off the machine.
3. Take out your laundry and close the loading door. Your machine is ready for the next washing cycle.

### 4.3.18 Your machine features "Standby Mode".

After you switch on your machine with On-Off button, if no programme is started or no other procedure is performed at the selection step or no action is taken within approx. 2 minutes after the selected programme ends, your machine will switch to energy saving mode automatically. The brightness of the indicator lights will decrease. Also, if your product has a display that shows programme time, this display will be completely turned off. If you turn the Programme Selection knob or touch any button, lights and display will switch back to previous condition. The selections which you make when exiting from the energy efficiency may change. Please check the correctness of your selections before starting the programme. If necessary, please make your settings again. This is not an error.

## 4.4 Maintenance and cleaning

Service life of the product extends and frequently faced problems decrease if cleaned at regular intervals.

### 4.4.1 Cleaning the detergent drawer

Clean the detergent drawer at regular intervals (every 4-5 washing cycles) as shown below in order to prevent accumulation of powder detergent in time.

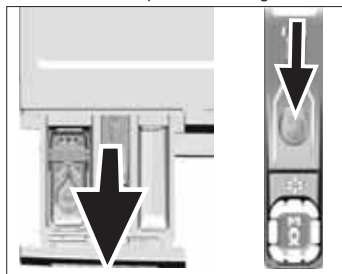

1. Press the dotted point on the siphon in the softener compartment and pull towards you until the compartment is removed from the machine.



If more than normal amount of water and softener mixture starts to gather in the softener compartment, the siphon must be cleaned.

2. Wash the detergent drawer and the siphon with plenty of lukewarm water in a washbasin. Wear protective gloves or use an appropriate brush to avoid touching of the residues in the drawer with your skin when cleaning.
3. Insert the drawer back into its place after cleaning and make sure that it is seated well.

**If your detergent drawer is the one indicated in the following figure:**

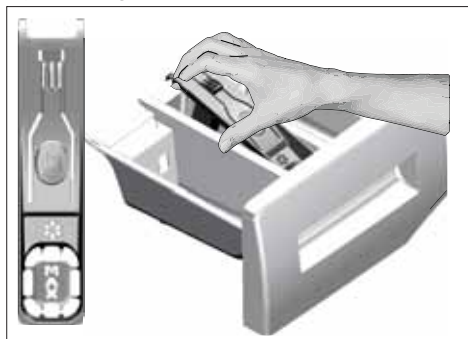

Lift the rear part of the siphon to remove it as illustrated. After performing the above mentioned cleaning procedures, replace the siphon back to its seating and push its front section downwards to make sure that the locking tab engages.

### 4.4.2 Cleaning the loading door and the drum

For products with drum cleaning programme, please see Operating the product - Programmes.



Repeat Drum Cleaning process in every 2 months.

Use an anti-limescale suitable for the washing machines.

**After every washing make sure that no foreign substance is left in the drum.**



If the holes on the bellow shown in the figure is blocked, open the holes using a toothpick.



Foreign metal substances will cause rust stains in the drum. Clean the stains on the drum surface by using cleaning agents for stainless steel. Never use steel wool or wire wool..



**CAUTION:** Never use sponge or scrub materials. These will damage the painted and plastic surfaces.

#### 4.4.3 Cleaning the body and control panel

Wipe the body of the machine with soapy water or non-corrosive mild gel detergents as necessary, and dry with a soft cloth.

Use only a soft and damp cloth to clean the control panel.

#### 4.4.4 Cleaning the water intake filters

There is a filter at the end of each water intake valve at the rear of the machine and also at the end of each water intake hose where they are connected to the tap. These filters prevent foreign substances and dirt in the water to enter the washing machine. Filters should be cleaned as they do get dirty.

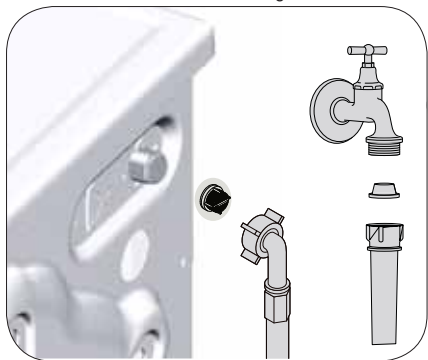

1. Close the taps.
2. Remove the nuts of the water intake hoses to access the filters on the water intake valves. Clean them with an appropriate brush. If the filters are too dirty, take them out by means of pliers and clean them.
3. Take out the filters on the flat ends of the water intake hoses together with the gaskets and clean thoroughly under running water.
4. Replace the gaskets and filters carefully in their places and tighten the hose nuts by hand.

#### 4.4.5 Draining remaining water and cleaning the pump filter

The filter system in your machine prevents solid items such as buttons, coins and fabric fibers clogging the pump impeller during discharge of washing water. Thus, the water will be discharged without any problem and the service life of the pump will extend.

If the machine fails to drain water, the pump filter is clogged. Filter must be cleaned whenever it is clogged or in every 3 months. Water must be drained off first to clean the pump filter.

In addition, prior to transporting the machine (e.g., when moving to another house) and in case of freezing of the water, water may have to be drained completely.



**CAUTION:** Foreign substances left in the pump filter may damage your machine or may cause noise problem.

##### In order to clean the dirty filter and discharge the water:

1. Unplug the machine to cut off the supply power.



**CAUTION:** Temperature of the water inside the machine may rise up to 90 °C. To avoid burning risk, filter must be cleaned after the water in the machine cools down.

2. Open the filter cap.

If the filter cap is composed of two pieces, press the tab on the filter cap downwards and pull the piece out towards yourself.



You can remove the filter cover by slightly pushing downwards with a thin plastic tipped tool, through the gap above the filter cover. Do not use metal tipped tools to remove the cover.

3. Some of our products have emergency draining hose and some does not have. Follow the steps below to discharge the water.

##### Discharging the water when the product has an emergency draining hose:

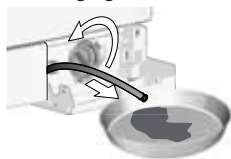

- a. Pull the emergency draining hose out from its seat
  - b. Place a large container at the end of the hose. Drain the water into the container by pulling out the plug at the end of the hose. When the container is full, block the inlet of the hose by replacing the plug. After the container is emptied, repeat the above procedure to drain the water in the machine completely.
  - c. When draining of water is finished, close the end by the plug again and fix the hose in its place.
  - d. Turn the pump filter to take it out.
4. Clean any residues inside the filter as well as fibers, if any, around the pump impeller region.
  5. Install the filter.
  6. If the filter cap is composed of two pieces, close the filter cap by pressing on the tab. If it is one piece, seat the tabs in the lower part into their places first, and then press the upper part to close.

## 5 Troubleshooting

Problem	Reason	Solution
Program does not start after closing the door.	Start / Pause / Cancel button was not pressed.	<ul style="list-style-type: none"> <li>• *Press the Start / Pause / Cancel button.</li> </ul>
	It may be difficult to close the loading door in case of excessive loading.	<ul style="list-style-type: none"> <li>• Reduce the amount of laundry and make sure that the loading door is closed properly.</li> </ul>
Programme cannot be started or selected.	Washing machine has switched to self protection mode due to a supply problem (line voltage, water pressure, etc.).	<ul style="list-style-type: none"> <li>• To cancel the programme, turn the Programme Selection knob to select another programme. Previous programme will be canceled. (see. "Cancellation of program")</li> </ul>
Water in the machine.	Some water might have remained in the product due to the quality control processes in the production.	<ul style="list-style-type: none"> <li>• This is not a failure; water is not harmful to the machine.</li> </ul>
The machine enters standby mode after the programme starts or it does not take in water.	Tap is turned off.	<ul style="list-style-type: none"> <li>• Turn on the taps.</li> </ul>
	Water inlet hose is bent.	<ul style="list-style-type: none"> <li>• Flatten the hose.</li> </ul>
	Water inlet filter is clogged.	<ul style="list-style-type: none"> <li>• Clean the filter.</li> </ul>
	Loading door may be open.	<ul style="list-style-type: none"> <li>• Close the door.</li> </ul>
	The water connection may be wrong or water may be cut off (When the water is cut off, washing or rinsing LEDs flash).	<ul style="list-style-type: none"> <li>• Check the water connection. If the water is cut off, press the Start/Pause key after the water has been supplied again to resume the operation from standby mode.</li> </ul>
Machine does not drain water.	Water drain hose might be clogged or twisted.	<ul style="list-style-type: none"> <li>• Clean or flatten the hose.</li> </ul>
	Pump filter is clogged.	<ul style="list-style-type: none"> <li>• Clean the pump filter.</li> </ul>
Machine vibrates or makes noise.	Machine might be standing unbalanced.	<ul style="list-style-type: none"> <li>• Adjust the feet to level the machine.</li> </ul>
	A hard substance might have entered into the pump filter.	<ul style="list-style-type: none"> <li>• Clean the pump filter.</li> </ul>
	Transportation safety bolts are not removed.	<ul style="list-style-type: none"> <li>• Remove the transportation safety bolts.</li> </ul>
	Laundry quantity in the machine might be too little.	<ul style="list-style-type: none"> <li>• Add more laundry to the machine.</li> </ul>
	Machine might be overloaded with laundry.	<ul style="list-style-type: none"> <li>• Take out some of the laundry from the machine or distribute the load by hand to balance it homogeneously in the machine.</li> </ul>
	Machine might be leaning on a rigid item.	<ul style="list-style-type: none"> <li>• Make sure that the machine is not leaning on anything.</li> </ul>
There is water leaking from the bottom of the washing machine.	Water drain hose might be clogged or twisted.	<ul style="list-style-type: none"> <li>• Clean or flatten the hose.</li> </ul>
	Pump filter is clogged.	<ul style="list-style-type: none"> <li>• Clean the pump filter.</li> </ul>
Machine stopped shortly after the programme started.	Machine might have stopped temporarily due to low voltage.	<ul style="list-style-type: none"> <li>• It will resume running when the voltage restores to the normal level.</li> </ul>
Machine directly discharges the water it takes in.	Draining hose might not be at adequate height.	<ul style="list-style-type: none"> <li>• Connect the water draining hose as described in the operation manual.</li> </ul>
No water can be seen in the machine during washing.	The water level is not visible from outside of the washing machine.	<ul style="list-style-type: none"> <li>• This is not a failure.</li> </ul>
Loading door cannot be opened.	Door lock is activated because of the water level in the machine.	<ul style="list-style-type: none"> <li>• Drain the water by running the Pump or Spin programme.</li> </ul>
	Machine is heating up the water or it is at the spinning cycle.	<ul style="list-style-type: none"> <li>• Wait until the programme completes.</li> </ul>
	Child lock is engaged. Door lock will be deactivated a couple of minutes after the programme has come to an end.	<ul style="list-style-type: none"> <li>• Wait for a couple of minutes for deactivation of the door lock.</li> </ul>
	Loading door may be stuck because of the pressure it is subjected to.	<ul style="list-style-type: none"> <li>• Grab the handle and push and pull the loading door to release and open it.</li> </ul>
Washing takes longer time than specified in the manual.(*)	Water pressure is low.	<ul style="list-style-type: none"> <li>• Machine waits until taking in adequate amount of water to prevent poor washing quality due to the decreased amount of water. Therefore, the washing time extends.</li> </ul>
	Voltage might be low.	<ul style="list-style-type: none"> <li>• Washing time is prolonged to avoid poor washing results when the supply voltage is low.</li> </ul>
	Input temperature of water might be low.	<ul style="list-style-type: none"> <li>• Required time to heat up the water extends in cold seasons. Also, washing time can be lengthened to avoid poor washing results.</li> </ul>
	Number of rinses and/or amount of rinse water might have increased.	<ul style="list-style-type: none"> <li>• Machine increases the amount of rinse water when good rinsing is needed and adds an extra rinsing step if necessary.</li> </ul>
	Excessive foam might have occurred and automatic foam absorption system might have been activated due to too much detergent usage.	<ul style="list-style-type: none"> <li>• Use recommended amount of detergent.</li> </ul>



<b>Problem</b>	<b>Reason</b>	<b>Solution</b>
Programme time does not countdown. (On models with display) (*)	Timer may stop during water intake.	<ul style="list-style-type: none"> <li>• Timer indicator will not countdown until the machine takes in adequate amount of water. The machine will wait until there is sufficient amount of water to avoid poor washing results due to lack of water. Timer indicator will resume countdown after this.</li> </ul>
	Timer may stop during heating step.	<ul style="list-style-type: none"> <li>• Timer indicator will not countdown until the machine reaches the selected temperature.</li> </ul>
	Timer may stop during spinning step.	<ul style="list-style-type: none"> <li>• Automatic unbalanced load detection system might be activated due to the unbalanced distribution of the laundry in the drum.</li> </ul>
Programme time does not countdown. (*)	There might be unbalanced load in the machine.	<ul style="list-style-type: none"> <li>• Automatic unbalanced load detection system might be activated due to the unbalanced distribution of the laundry in the drum.</li> </ul>
Machine does not switch to spinning step. (*)	There might be unbalanced load in the machine.	<ul style="list-style-type: none"> <li>• Automatic unbalanced load detection system might be activated due to the unbalanced distribution of the laundry in the drum.</li> </ul>
	The machine will not spin if water is not drained completely.	<ul style="list-style-type: none"> <li>• Check the filter and the draining hose.</li> </ul>
	Excessive foam might have occurred and automatic foam absorption system might have been activated due to too much detergent usage.	<ul style="list-style-type: none"> <li>• Use recommended amount of detergent.</li> </ul>
Washing performance is poor: Laundry turns gray. (**)	Insufficient amount of detergent has been used over a long period of time.	<ul style="list-style-type: none"> <li>• Use the recommended amount of detergent appropriate for water hardness and the laundry.</li> </ul>
	Washing was made at low temperatures for a long time.	<ul style="list-style-type: none"> <li>• Select the proper temperature for the laundry to be washed.</li> </ul>
	Insufficient amount of detergent is used with hard water.	<ul style="list-style-type: none"> <li>• Using insufficient amount of detergent with hard water causes the soil to stick on the cloth and this turns the cloth into gray in time. It is difficult to eliminate graying once it happens. Use the recommended amount of detergent appropriate for water hardness and the laundry.</li> </ul>
	Too much detergent is used.	<ul style="list-style-type: none"> <li>• Use the recommended amount of detergent appropriate for water hardness and the laundry.</li> </ul>
Washing performance is poor: Stains persist or the laundry is not whitened. (**)	Insufficient amount of detergent is used.	<ul style="list-style-type: none"> <li>• Use the recommended amount of detergent appropriate for water hardness and the laundry.</li> </ul>
	Excessive laundry was loaded in.	<ul style="list-style-type: none"> <li>• Do not load the machine in excess. Load with amounts recommended in the "Programme and consumption table".</li> </ul>
	Wrong programme and temperature were selected.	<ul style="list-style-type: none"> <li>• Select the proper programme and temperature for the laundry to be washed.</li> </ul>
	Wrong type of detergent is used.	<ul style="list-style-type: none"> <li>• Use original detergent appropriate for the machine.</li> </ul>
	Too much detergent is used.	<ul style="list-style-type: none"> <li>• Put the detergent in the correct compartment. Do not mix the bleaching agent and the detergent with each other.</li> </ul>
Washing performance is poor: Oily stains appeared on the laundry. (**)	Regular drum cleaning is not applied.	<ul style="list-style-type: none"> <li>• Clean the drum regularly. For this, please see 4.4.2.</li> </ul>
Washing performance is poor: Clothes smell unpleasantly. (**)	Odours and bacteria layers are formed on the drum as a result of continuous washing at lower temperatures and/or in short programmes.	<ul style="list-style-type: none"> <li>• Leave the detergent drawer as well as the loading door of the machine ajar after each washing. Thus, a humid environment favorable for bacteria cannot occur in the machine.</li> </ul>
Colour of the clothes faded. (**)	Excessive laundry was loaded in.	<ul style="list-style-type: none"> <li>• Do not load the machine in excess.</li> </ul>
	Detergent in use is damp.	<ul style="list-style-type: none"> <li>• Keep detergents closed in an environment free of humidity and do not expose them to excessive temperatures.</li> </ul>
	A higher temperature is selected.	<ul style="list-style-type: none"> <li>• Select the proper programme and temperature according to the type and soiling degree of the laundry.</li> </ul>

<b>Problem</b>	<b>Reason</b>	<b>Solution</b>
It does not rinse well.	The amount, brand and storage conditions of the detergent used are inappropriate.	<ul style="list-style-type: none"> <li>Use a detergent appropriate for the washing machine and your laundry. Keep detergents closed in an environment free of humidity and do not expose them to excessive temperatures.</li> </ul>
	Detergent is put in the wrong compartment.	<ul style="list-style-type: none"> <li>If detergent is put in the prewash compartment although prewash cycle is not selected, machine can take this detergent during rinsing or softener step. Put the detergent in the correct compartment.</li> </ul>
	Pump filter is clogged. Drain hose is folded.	<ul style="list-style-type: none"> <li>Check the filter.</li> <li>Check the drain hose.</li> </ul>
Laundry became stiff after washing. (**)	Insufficient amount of detergent is used.	<ul style="list-style-type: none"> <li>Using insufficient amount of detergent for the water hardness can cause the laundry to become stiff in time. Use appropriate amount of detergent according to the water hardness.</li> </ul>
	Detergent is put in the wrong compartment.	<ul style="list-style-type: none"> <li>If detergent is put in the prewash compartment although prewash cycle is not selected, machine can take this detergent during rinsing or softener step. Put the detergent in the correct compartment.</li> </ul>
	Detergent might be mixed with the softener.	<ul style="list-style-type: none"> <li>Do not mix the softener with detergent. Wash and clean the dispenser with hot water.</li> </ul>
Laundry does not smell like the softener. (**)	Detergent is put in the wrong compartment.	<ul style="list-style-type: none"> <li>If detergent is put in the prewash compartment although prewash cycle is not selected, machine can take this detergent during rinsing or softener step. Wash and clean the dispenser with hot water. Put the detergent in the correct compartment.</li> </ul>
	Detergent might be mixed with the softener.	<ul style="list-style-type: none"> <li>Do not mix the softener with detergent. Wash and clean the dispenser with hot water.</li> </ul>
Detergent residue in the detergent drawer. (**)	Detergent is put in wet drawer.	<ul style="list-style-type: none"> <li>Dry the detergent drawer before putting in detergent.</li> </ul>
	Detergent has gotten damp.	<ul style="list-style-type: none"> <li>Keep detergents closed in an environment free of humidity and do not expose them to excessive temperatures.</li> </ul>
	Water pressure is low.	<ul style="list-style-type: none"> <li>Check the water pressure.</li> </ul>
	The detergent in the main wash compartment got wet while taking in the prewash water. Holes of the detergent compartment are blocked.	<ul style="list-style-type: none"> <li>Check the holes and clean if they are clogged.</li> </ul>
	There is a problem with the detergent drawer valves.	<ul style="list-style-type: none"> <li>Call the Authorized Service Agent.</li> </ul>
	Detergent might be mixed with the softener.	<ul style="list-style-type: none"> <li>Do not mix the softener with detergent. Wash and clean the dispenser with hot water.</li> </ul>
Too much foam forms in the machine. (**)	Regular drum cleaning is not applied.	<ul style="list-style-type: none"> <li>Clean the drum regularly. For this, please see 4.4.2.</li> </ul>
	Improper detergents for the washing machine are being used.	<ul style="list-style-type: none"> <li>Use detergents appropriate for the washing machine.</li> </ul>
	Excessive amount of detergent is used.	<ul style="list-style-type: none"> <li>Use only sufficient amount of detergent.</li> </ul>
	Detergent was stored under improper conditions.	<ul style="list-style-type: none"> <li>Store detergent in a closed and dry location. Do not store in excessively hot places.</li> </ul>
	Some meshed laundry such as tulle may foam too much because of their texture.	<ul style="list-style-type: none"> <li>Use smaller amounts of detergent for this type of item.</li> </ul>
	Detergent is put in the wrong compartment. Softener is being taken early.	<ul style="list-style-type: none"> <li>Put the detergent in the correct compartment.</li> <li>There may be problem in the valves or in the detergent dispenser. Call the Authorized Service Agent.</li> </ul>
Foam is overflowing from the detergent drawer.	Too much detergent is used.	<ul style="list-style-type: none"> <li>Mix 1 tablespoonful softener and ½ l water and pour into the main wash compartment of the detergent drawer.</li> </ul>
		<ul style="list-style-type: none"> <li>Put detergent into the machine suitable for the programmes and maximum loads indicated in the "Programme and consumption table". When you use additional chemicals (stain removers, bleaches and etc), reduce the amount of detergent.</li> </ul>

Problem	Reason	Solution
Laundry remains wet at the end of the programme. (*)	Excessive foam might have occurred and automatic foam absorption system might have been activated due to too much detergent usage.	<ul style="list-style-type: none"> <li>• Use recommended amount of detergent.</li> </ul>
(*) Machine does not switch to spinning step when the laundry is not evenly distributed in the drum to prevent any damage to the machine and to its surrounding environment. Laundry should be rearranged and re-spun.		
(**) Regular drum cleaning is not applied. Clean the drum regularly. See 4.4.2		
	<b>CAUTION:</b> If you cannot eliminate the problem although you follow the instructions in this section, consult your dealer or the Authorized Service Agent. Never try to repair a nonfunctional product yourself.	

Distributed by:

**Glen Dimplex Australia Pty Ltd**

[www.glendimplex.com.au](http://www.glendimplex.com.au)

**Glen Dimplex New Zealand Ltd**

[www.glendimplex.co.nz](http://www.glendimplex.co.nz)

For service advice please contact the Customer Care Centre by phone or email below.

**Australia**

Ph: 1300 556 816

[customer.care.ha@glendimplex.com.au](mailto:customer.care.ha@glendimplex.com.au)

**New Zealand**

Ph: 09 274 8265

[nztechserv@glendimplex.co.nz](mailto:nztechserv@glendimplex.co.nz)