

Euromaid

User Manual

52cm Glass Undermount Rangehood

UCG52B/W

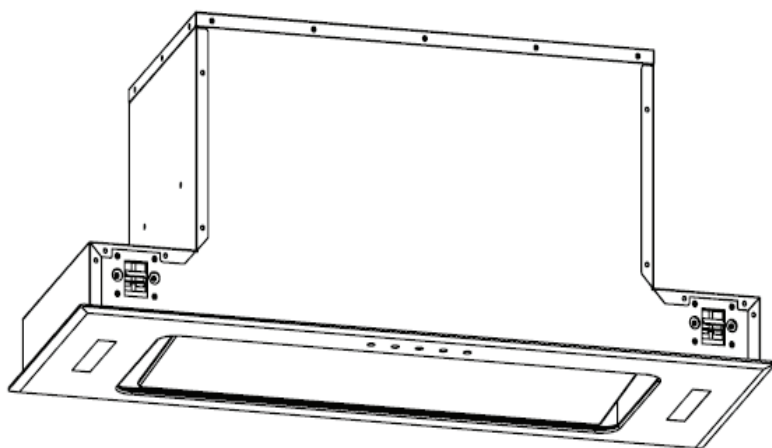

Product/Installer details

For future reference we suggest that you staple a copy of your purchase receipt here and complete the below so the information is always at hand.

Product Details

Model number: _____

Description: _____

Serial number: _____

(Located on the product rating label)

Purchase Details

Date of purchase: _____

Place of purchase: _____

Store name: _____

Address: _____

Telephone: _____

Invoice/receipt number: _____

Installation Details

Electrical date of installation: _____

Electrician Installers Details: Company/Installers Name: _____

Licence Number: _____

Telephone Number: _____

Gas date of installation: _____

Gas installers details: Company/Installers Name: _____

Licence Number: _____

Telephone Number: _____

Plumbing date of installation: _____

Plumbers installers details: Company/Installers Name: _____

Licence Number: _____

Telephone Number: _____

CONTENT

1	Safety Warning
2	Function & Feature
3	Installation
4	Operation
5	Maintenance
6	Abnormity and Solution

SAFETY WARNINGS

- Installation of this Integrated Canopy Rangehood must be carried by a Qualified and competent installer electrician. Before you use the Rangehood, make sure that the voltage (V) and the frequency (Hz) indicated on the Rangehood are exactly the same as the voltage (V) and the frequency (Hz) in your home.
 - HAPL will not bear any responsibility for the damage or injury caused as a result of not following this instruction manual or by inappropriate installation and usage.
 - This Integrated Rangehood is not intended for use by young children or infirm persons without supervision. Young children should not play with this Integrated Rangehood. Please ensure children supervised when near the Rangehood.
 - To avoid possible electric shock this Integrated Rangehood should be unplugged before any maintenance or cleaning is carried out.
 - This Integrated Rangehood cannot be installed in an external environment, and it is not recommended for use over Barbeques.
 - The Grease Filters should be cleaned at least once a month to avoid the risk of fire.
 - Flambé cooking cannot be carried out under the Integrated Rangehood.
 - Ducting must be independent from any other form of ducting of other Household heating sources. Ducting into wall cavities is prohibited unless the cavity has been designed for this purpose.
 - A gas burner that has been ignited should never remain uncovered or on when there is no pan present due to the risk of fire.
 - Adequate ventilation of the room is required when the cooker hood is used at the same time as appliances that use gas or other fuels.
- CAUTION: Accessible parts may become hot when used with cooking appliances.

FUNCTION AND FEATURE

1. The cooker hood is made of high quality materials with streamlined design accordingly to technical and physical engineering theory, high end and luxury with age aesthetic feeling, also there are kinds of styles for your option to perfect your kitchen.
2. The Rangehood quipped with a large power low noise electric motor and centrifugal fan, it produces strong extraction, low noise, non-stick grease filter and is easy to clean.
3. The grease filter is easy to remove and clean in warm soapy water. The motor and other internal parts should only be wiped lightly with a paper towel or damp cloth. Please ensure the power is turned off when cleaning to avoid any injury.

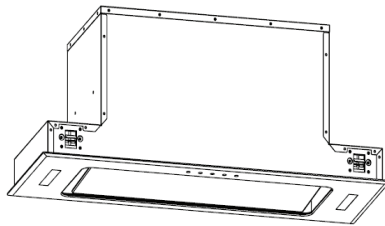

1. INSTALLATION

- 1) For optimum performance, Euromaid recommends that all Rangehood clearances be a minimum of 650mm to a maximum of 750mm between the top of the cooking surface to the underside of the Rangehood. The distance may be reduced to 600mm to align with AS/NZS 5601.
- 2) Measure and cut a hole in the cabinet, with a width of 505 x275mm (UCG52) and 880x280mm (UCG90), and then centre above the cooktop. Ensure the distance between the edges of the cut-out to the edge of the cupboard is at least 35mm.
- 3) Place the hood into the cabinet, and tighten up the screws with a screwdriver, and make sure the hood is fixed securely.
- 4) Once the Rangehood is installed, we recommend that the appropriate Ducting Kit for the installation should be used for the best results.

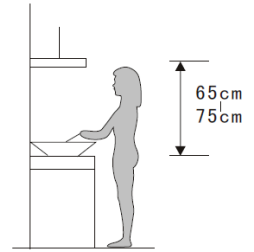

Pic 1

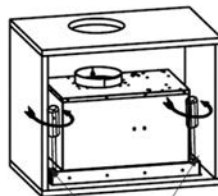
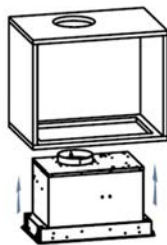
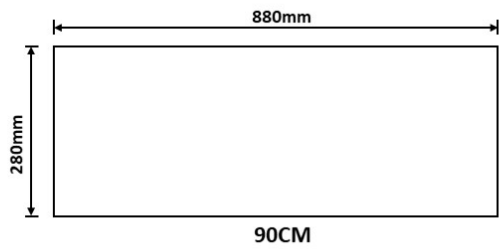
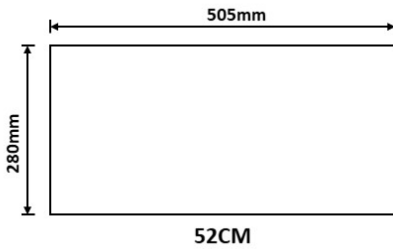

Tighten the screw
anticlockwise

Pic 2

Warning: Failure to install the screws or fixing the rangehood in accordance with these instructions may result in electrical hazards

2. OPERATION

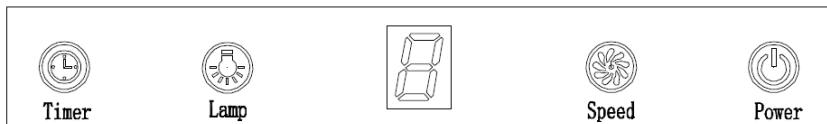



LED Touch control has four buttons:  (Timer),  (Lamp),  (Speed)

 (Power). See Pic

1. Power on: After you have connected the rangehood to the mains supply, the backlight of button will turn on. The backlight will turn off after 30 seconds if no operation has been detected, and the rangehood will enter into stand-by mode.

2. Press  button once, lights will be on. Press  button again; lights will be off.

3. Turn on hood and select the speed, use button "" , the motor works at 3 speeds, low, mid and high, and the LED display will display "1", "2", "3".

Press  once, the motor starts to work at low speed and the LED display will display "1",

Press  again base on the low speed, the motor works at mid speed and the LED display will display "2",

Press  again base on the mid speed, the motor works at high speed and the LED display will display "3".

Go on pressing  button, the hood works at low speed again and it repeats: "low→mid→high→low→mid..."

4. Press  button once, the hood will work at the speed which it was on last use.

Press  button again, the hood will stop working.

5. The time button  will work only when the motor is working.

Press , the rangehood enters into timer setting mode. The max delay time is 9 minutes, and the LED display will display "9".

When the timer is set, the LED display will display "9","8","7"decreasing by every minute, when it displays "1", the motor will continue working for 60s and then stop.

Press  once, the rangehood will enter into the timer setting mode, press



once again, the rangehood will exit the timer setting mode. Press  once when the cooker hood is working at timer setting, the cooker hood will exit the timer setting mode automatically.

3. MAINTENANCE

- 1) The rangehood and its filters should be cleaned regularly in order to keep them in good working order. Because the grease filters are made of metal, do not clean the filters with corrosive detergents that damage metal products.

Clean the filters as below:

- a) Method one:

Put the filter in the water (40 - 50°C), pour in some grease-loosening detergent, soak it for about 2-3 minutes and then clean it with a soft brush. Do not brush too hard so as not to damage the filter.

- 2) To protect the main body from corrosion over a long period of time, the rangehood should be cleaned with warm soapy water or non-corrosive detergent once a week. Do not use grinding detergent, or it will damage the body.
- 3) Keep the motor and other spare parts free from water, as this will cause damage to the appliance.
- 4) The replacement of the LED light should only be carried out by a qualified technician.
- 5) Disassembly and assembly the filter:

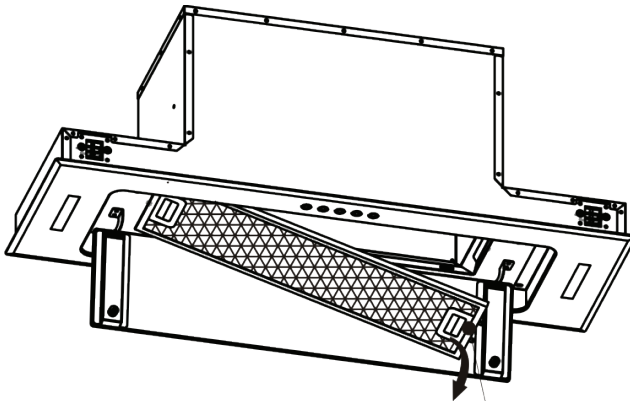

4. ABNORMITY AND SOLUTION

Fault	Cause	Solution
Light does not work, but motor work	The bulb damaged	Change bulb
	Bulb contact lamp cap bad	Fix or change
	Light panel switch damage	Fix or change
Light work, but motor does not work	Bulb contact lamp cap	Restart later
	Motor bearings damage	Change motor
	Motor burn out	Change motor
	Motor control switch damage	Fix or change
Light does not work, motor does not work	Plug contact outlet bad	Fix or change
	Power wire cut off	Change power wire
	Switch damage	Fix or change
Shake of the body	Wind leaves damage	Change leaves
	Motor screw loosen	Screw it tight
	Combination screw loosen	Screw it tight
	Body hang unfixable	Tight the body
Insufficient suction	The distance between the body and the gas top too long	Readjust the distance
	Cross-ventilation too strong or too closed in the kitchen	Reduce cross-ventilation or open the window
	Exhaust pipe too long	Adjust the length of pipe
	Air outlet valve not open	Check the valve if flexible
	The outside wind is too strong	No the technical problem

MANUFACTURER GUARANTEE

This warranty is provided in Australia by Glen Dimplex Australia Pty Limited ABN 69 118 275 460 **(Phone number 1300 556 816)** and in New Zealand by Glen Dimplex New Zealand Limited ACN 9429000069823 **(Phone number 09 274 8265)** in respect of the **Euromaid** product.

1. Euromaid Express Warranty

Subject to the exclusions below, we warrant that the product will not have any electrical or mechanical breakdowns within:

- a) In the case of **Euromaid** products used for personal, domestic or household purposes, a period of **2 years** from the date the product is purchased as a brand-new product from a retailer located in Australia / New Zealand.
- b) In the case of **Euromaid** products used for purposes other than personal, domestic or household purposes (including business or commercial use), a period of 90 days from the date the product is purchased as a brand-new product from a retailer located in Australia / New Zealand.
Euromaid products are designed and intended for domestic use only; and
- c) All warranty repairs must be carried out by Glen Dimplex or their nominated service agent

Note: warranty periods detailed above may vary in line with agreements with select retail and builder partners and may differ between Australia and New Zealand.

The benefits conferred by this express warranty are in addition to the Consumer Guarantees referred to in section 3 and any other statutory rights you may have under the Australian / New Zealand Consumer Law and/or other applicable laws.

2. Warranty exclusions

This express warranty does not apply where:

- a) The product has been installed, used or operated otherwise than in accordance with the product manual or other similar documentation provided to you with the product;
- b) The product requires repairs due to damage resulting from accident, misuse, incorrect installation, insect or vermin infestation, improper liquid spillage, cleaning or maintenance, unauthorised modification, use on an incorrect voltage, power surges and dips, voltage supply problems, tampering or unauthorised repairs by any persons, use of defective or incompatible accessories or exposure to abnormally corrosive conditions, events independent of human control which occurred after the goods left the control of Glen Dimplex;

- c) The repair relates to the replacement of consumable parts such as fuses and bulbs or any other parts of the product which require routine replacement;
- d) You are unable to provide us with reasonable proof of purchase for the product;
- e) the breakdown occurs after the expiry of the express warranty period set out in section 1 or
- f) the product was not purchased in Australia / New Zealand as a brand-new product.

3. Consumer guarantees

Our goods come with guarantees that cannot be excluded under the Australian / New Zealand Consumer Law. You are entitled to a replacement or refund for a major failure and for compensation for any other reasonably foreseeable loss or damage. You are also entitled to have the goods repaired or replaced if the goods fail to be of acceptable quality and the failure does not amount to a major failure.

4. How to make a claim

You may make a claim under this warranty through our website, contacting our customer care line or via email. Contact details for Glen Dimplex Australia and New Zealand can be found at the end of this document

To make a valid claim under this warranty, you must:

- a) Lodge the claim with us as soon as possible and no later than 14 days after you first become aware of the breakdown;
- b) Provide us with the product serial number;
- c) Provide us with reasonable proof of purchase for the product. This can take the form of a store receipt, new home handover form or other payment receipt documentation; and
- d) If required by us, provide us (or any person nominated by us) with access to the premises at which the product is located at times nominated by us (so that we can inspect the product).

5. Warranty claims

If you make a valid claim under this warranty and none of the exclusions set out in section 2 apply, we will, at our election, either repair the product or replace the product with a product of identical specification (or where the product is superseded or no longer in stock, with a product of as close a specification as possible).

Goods presented for repair may be replaced by refurbished goods of the same type rather than being repaired. Refurbished parts may be used to repair the goods.

Products are designed and supplied for normal domestic use. We will not be liable to you under this warranty for business loss or damage of any kind whatsoever.

Glen Dimplex Australia Pty Ltd

www.glendimplex.com.au

Australia

Ph: 1300 556 816

customer.care.ha@glendimplex.com.au

Glen Dimplex New Zealand Ltd

www.glendimplex.co.nz

New Zealand

Ph: 09 274 8265

nztechserv@glendimplex.co.nz

READ THE INSTRUCTION BOOKLET BEFORE INSTALLING AND USING THE APPLIANCE.

The manufacturer will not be responsible for any damage to property or to persons caused by incorrect installation or improper use of the appliance.

The manufacturer is not responsible for any inaccuracies, due to printing or transcription errors, contained in this manual. In addition, the appearance of the figures reported is also purely indicative.

The manufacturer reserves the right to make changes to its products when considered necessary and useful, without affecting the essential safety and operating characteristics.

Glen Dimplex constantly seeks ways to improve the specifications and designs of their products. Whilst every effort is made to produce up to date literature, this document should not be regarded as an infallible guide. Actual product only should be used to derive cut out sizes.

All appliances must be installed by a qualified person/s with adherence to the relevant electrical, plumbing and building codes, with compliance being issued as required by state or national legislation.

Additionally, all upright cookers must have the anti-tilt device installed correctly in adherence to the relevant standards by a licenced installer.

For maximum effectiveness and efficiency all rangehoods should be installed with the use of ductwork, by a licenced installer with adherence to the relevant state and national building codes and regulations.

All Glen Dimplex appliances are for Domestic use only, and must be installed by a licence installer into Domestic Applications only, without exception and to the required Authorities guidelines. Any installation outside of this will VOID warranty. Alfresco areas are not a Domestic application.

Euromaid

Distributed by:

Glen Dimplex Australia Pty Ltd

www.glendimplex.com.au

Glen Dimplex New Zealand Ltd

www.glendimplex.co.nz

For service advice, please contact the Customer Care Centre by phone or email below.

Australia

Ph: 1300 556 816

customer.care.ha@glendimplex.com.au

New Zealand

Ph: 09 274 8265

nztechserv@glendimplex.co.nz