

900mm Ceramic Freestanding Cooker Manual

MODEL

FC9PS - Stainless Steel

Euromaid

Installation and Operation

Contents

For your safety

Safety of children and the infirm	3
Cleaning and maintenance	3
During use	4
Installation	5
Service and spare parts	7

Use and Care

Description of the appliance	8
Oven & Accessories	10
Controls	11
How to use your hob	12
How to use your oven	15
Positioning the oven trays & shelves	16
Cooking modes	17
3-button digital clock	19
Practical cooking advice	21
Cooktop cleaning & maintenance	26
Oven cleaning & maintenance	27
Disposal	30

Installation

Technical data	31
Instructions for Installation	32
Dimensions	33
Combustible surfaces	33
Anti-tilting chain	34
Electrical connection	35
Replacing the power supply lead	35
Before leaving	35

For Your Safety

We recommend that you read the instructions in this owner's manual carefully before use for the best performance and to extend the life of your appliance. It will provide you with all the information you need to ensure its safe installation, use and maintenance. Retain this owner's manual for future reference.

To maintain the efficiency and safety of this appliance, we recommend that you do the following:

- Always call the Euromaid service department if there are any faults with your appliance.
- Always use original spare parts available from Euromaid.
- This appliance is designed for non-commercial, household use and it must not be altered in any way.
- **This appliance can only be used safely when it is correctly connected to an efficient earthing system in compliance with current electrical safety standards.**
- **If the supply cord or plug is damaged, it must be replaced by the manufacturer or its service agent or a similarly qualified person in order to avoid a hazard.**
- **The appliance is not intended to be operated by means of an external timer or separate remote-control system.**
- **The appliance should not be placed on a base**

Packaging items such as plastic bags, polystyrene, nails, etc. are potentially dangerous, and therefore appropriate measures must be taken to prevent children and the disabled from coming into contact with them.

Safety of children and the infirm

This appliance must only be used by adults. Make sure that children do not touch the controls or play with the appliance.

The exposed parts of this appliance heat up during cooking and remain hot for some time even after it is switched off. Keep children well away until the appliance has cooled down.

Cleaning and maintenance

Keep the appliance thoroughly cleaned. Food residues may cause fire risks.

For Your Safety

During use

- The appliance becomes hot. Take care not to touch the surface of the hob. Care should be taken to avoid touching heating elements inside the oven. To avoid burns and scalds, children should be kept away.
- **WARNING: Accessible parts will become hot when in use. To avoid burns and scalds, children should be kept away.**
- This appliance is not intended for use by persons (including children) with reduced physical, sensory or mental capabilities, or lack of experience and knowledge, unless they have been given supervision or instruction concerning use of the appliance by a person responsible for their safety.
- Young children should be supervised to ensure that they do not play with the appliance.
- **DO NOT use a steam cleaner to clean the appliance.**
- This product is designed to cook foods inside private homes and for non-commercial purposes. It should not be used for any other purpose.
- After using the appliance, make sure that all controls are in 'CLOSED' or 'OFF' position.
- **DO NOT USE OR STORE FLAMMABLE MATERIALS IN THE APPLIANCE STORAGE DRAWER OR NEAR THIS APPLIANCE.**
- **DO NOT STORE OR USE FLAMMABLE LIQUIDS OR ITEMS IN THE VICINITY OF THIS APPLIANCE.**
- Only use the appliance to cook food and nothing else.
- If the surface is cracked, switch off the appliance to avoid the possibility of electric shock.
- Disconnect the appliance from the electrical mains if it is not functioning properly and before cleaning or performing maintenance.
- The use of suitable heat proof gloves should be worn when handling hot utensils and pans.
- Use oven gloves to place cookware in the oven or when removing it. Always grip the oven door handle in the centre.

For Your Safety

Installation

- Installation of the appliance and its connection to the electrical mains must only be carried out by **Authorised Personnel**. Before any service procedure, it is important to check that the appliance is **DISCONNECTED** from the electrical mains.
- **DO NOT MODIFY THIS APPLIANCE.**
- After removing the appliance from the packaging, make sure that it is undamaged and that the electrical lead is in perfect condition. Otherwise, contact your dealer before operating the appliance.
- Make sure that air is able to circulate freely around the appliance.
- **WARNING:** In order to prevent accidental tipping of the appliance, for example a child climbing onto the open oven door, the stabilising means must be installed. Refer to the instructions for installation.
- **Euromaid will not accept any liability as a result of any damage due to incorrect installation or improper use.**

For Your Safety

Avoid the following:

- Touching the appliance with wet parts of the body.
- Using the appliance while barefoot.
- Improper or dangerous operation.
- Obstructing the ventilation or heat dissipation slots.
- Allowing power supply cables of other appliances to come into contact with hot parts of the oven.
- Exposing the appliance to atmospheric agents such as rain, or direct sunlight.
- Using the oven for storage purposes.
- Using flammable liquids near the appliance.
- Take care not to spill sugar or sweet mixtures on to the ceramic glass surface when hot. Never place materials or substances on the ceramic glass which may melt (plastic or aluminium foil). In the event of this happening, promptly switch off and remove the molten material while the cooking zone is still warm, to prevent it from being damaged. Failure to instantly clean the ceramic glass could lead to incrustations, which are impossible to remove once the hob has cooled down.

Authorised personnel must be contracted to...

- Install the appliance according to these installation instructions and any local requirements.
- Replace the temperature probe if it is damaged. The probe is part of thermostat. Only use the temperature sensing probe recommended for this oven.

Euromaid Service Department must be contacted...

- If in doubt about the operation of the appliance.
- If in doubt about the soundness of the appliance after removing it from its packaging.
- If the power supply cable has been damaged or needs to be replaced.
- If the appliance requires a service or you need spare parts.

For Your Safety

Service and spare parts

If the appliance fails to operate correctly, never attempt to repair the appliance yourself. Repairs by unskilled persons may cause damage and accidents. First refer to the contents of this manual. If you do not find the necessary information, contact your nearest Service Center. Servicing work on this appliance must be carried out by Authorised Personnel. Always request the use of original spare parts.

Use and Care

Description of the appliance

- | | |
|---|------------------------|
| 1. Electronic clock | 6. Cooktop burner - A |
| 2. Control knob (cooktop burners) | 7. Cooktop burner - B |
| 3. Cooking temperature selection knob | 8. Cooktop burner - C |
| 4. Cooking mode selection knob | 9. Cooktop burner - D |
| 5. Power & residual heat warning lights | 10. Cooktop burner - E |
| | 11. Cooktop burner - F |

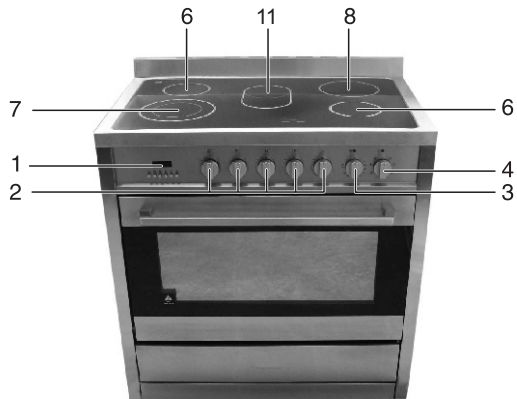

Note: Material and colours may vary on some models.

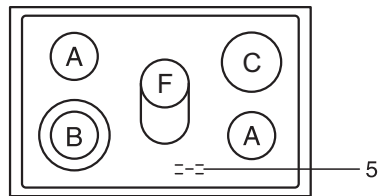

- A. Single cooking zone: 1300W
- B. Dual cooking zone: 2395W/1088W
- C. Single cooking zone: 1960W
- D. Single cooking zone: 2500W
- E. Dual cooking zone: 1850W/760W
- F. Dual cooking zone: 2180W/1200W

Use and Care

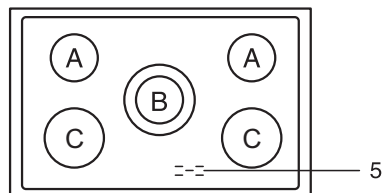
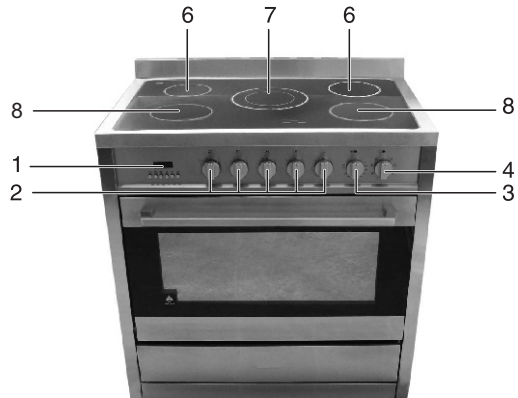
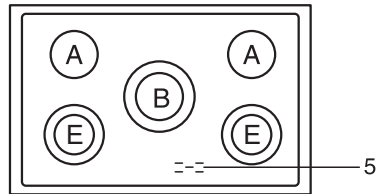
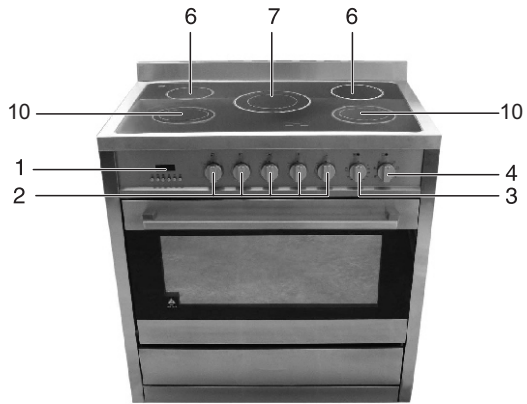

Use and Care

Oven & accessories

The oven is supplied with chrome wire Shelf Supports and a range of shelf options as shown below. There are four shelf positions on the oven.



Use and Care

Controls



- Decrease time
- Function
- + Increase time



Control Knob
(Cooktop Burners)

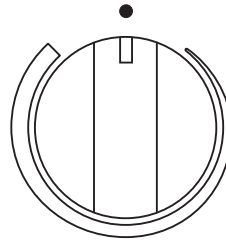

Cooking Temperature
Selection Knob

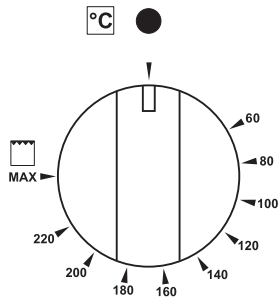

Cooking Mode
Selection Knob

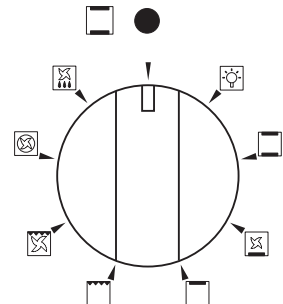

Use and Care

HOW TO USE YOUR HOB

Before first Use

Before cooking for the first time the ceramic glass has to be cleaned. Remove any removable labels and protective sheeting.

Place a saucepan of water on each of the front hotplates and switch them on high for at least 30 minutes. After 30 minutes switch the front hotplates off, place a saucepan of water on each of the rear hotplates and the central hotplate (if present). Switch them on high for at least 30 minutes. This procedure is necessary in order to evaporate any protective oils and humidity that may have collected during the manufacturing process and will enable the electronic control circuits to operate properly.

Pot sizes

The pot sizes stated in the table below are suitable for your electric hob. Solid pots and pans with flat bottoms are recommended for efficient cooking.

Hotplate diameter	140mm	180mm	220mm
Pot diameter	160mm	200mm	240mm

Use and Care

Description of symbols



Front
Left



Rear
Left



Centre



Rear
Right



Front
Right



Off

Single cooking zones

Turn the control knob to the desired position (low to high). Adjustment is continuous so the cooking zone will operate at any intermediate knob setting between low & high. Once the cooking zone is hot, the LED corresponding to the zone illuminates.

You can switch off the cooking zone by turning the knob, in either direction, to the off ● position. The residual heat warning light remains illuminated when the temperature of the ceramic glass surface is hot and it will switch off once the surface temperature has cooled.

Dual cooking zones

Turn the control knob clockwise to the desired position between low and halfway as shown on the diagram on page 13. The inner cooking zone will heat and the outer cooking zone is off. Adjustment is continuous so the cooking zone will operate at any intermediate knob setting between low & halfway. Once the inner cooking zone is hot, the lamp corresponding to the zone illuminates.

To operate the outer cooking zone, turn the knob past the half way setting. Both inner and outer cooking zones will operate. Adjustment is continuous so the both zones will operate at any intermediate knob setting between halfway & max. For highest setting with both zones operating, turn the knob past max, to the detent position (between max & ●). To reduce heat setting, but continue to operate both zones, turn the knob anywhere between maximum and halfway setting.

To return to operating the inner cooking zone only, turn the knob anticlockwise to between halfway and low.

Use and Care

Note: You can turn the knob in either direction from any position to the setting you select.

The residual heat warning lamp remains illuminated when the temperature of the ceramic glass surface is hot and it will switch off once the surface temperature has cooled.

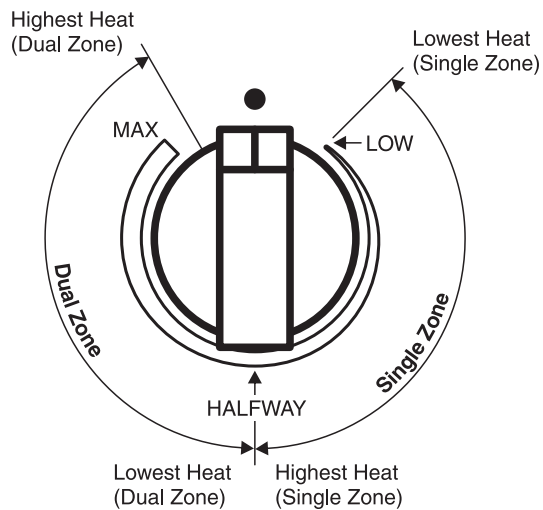

Practical cooking advice

For best results and energy saving, only use pans suitable for electric cooking:

- The bottom of the pan must be very thick and perfectly flat; before placing on the hotplate, make sure that the pan, as well as the hotplate itself, is perfectly clean and dry.
- To avoid scratching of the ceramic glass surface, never use cast-iron pans or pans with a rough bottom.
- To avoid wasting energy, make sure that the diameter of the pan bottom is 20mm bigger than the circle marked on the hotplate.

Use and Care

How to use your oven

This multi-function oven combines the advantages of traditional convection ovens with modern fan assisted ovens in a single appliance. It is an extremely versatile appliance that allows you to choose easily and safely between different cooking modes. The various cooking modes are selected by means of a cooking mode selection knob, located on the control panel.

To operate the oven:

- Ensure that manual mode is selected (page 18)
- Turn the cooking mode selection knob to the desired cooking mode (explanation of cooking modes is on pages 16 to 17)
- Turn the cooking temperature selection knob to the desired temperature (cooking guide is on pages 25 to 26) or to 'MAX' if Grilling.

The first time you use your appliance, we recommend that you set the thermostat to the highest setting, set the cooking mode selection knob to a cooking mode and leave the oven on for about half an hour with nothing in it and the oven door closed. Then, open the oven door and allow the oven to cool. Any odour that may be detected during this initial use is due to the evaporation of substances used to protect the oven during storage.

Note: Place tray on the bottom shelf position of the oven to prevent any spillages from dripping onto the bottom of the oven. **Never place anything (including foil and oven trays) on the bottom of the oven when it is in operation because this could damage the enamel.** Only place your cookware (dishes, trays, aluminum foil, etc.) on the Oven Shelves provided with the appliance.



If supplied, use the chrome wire handle shown left when removing the trays from the oven.

Use and Care

Positioning the oven trays & shelves

The Grill Tray or Oven Shelf can be located in any of the five height positions in the oven.

Refer to the 'Cooking Mode Table' for the recommended shelf position. When fitting the trays or shelves, ensure they are fitted between the two wires that are closest together as shown below. Oven Shelves have a stop so that they are not fully withdrawn by accident. To fully remove the Oven Shelves, lift the front of the shelf slightly and withdraw fully from the oven. Note that the Grill Tray does not have a stop position and can be fully withdrawn without interruption, so be careful not to accidentally fully withdraw the tray.

Fit Trays and Shelves between bars as shown right

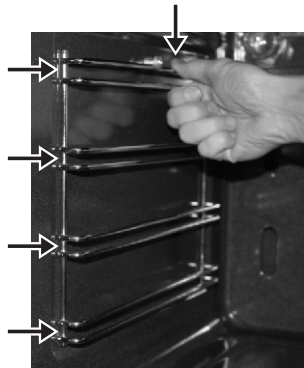

To remove the Oven Shelf Support, push down on the wire below the locking pin, pull away from the oven wall until you can release the bottom of the support from the holes in the oven wall. Replace in reverse procedure.



Oven Shelf fitted to chrome wire Shelf Support

Use and Care

COOKING MODES

Convection mode

When set to Convection mode, the top and bottom heating elements operate together like a 'normal' conventional oven that you have probably used before.

Convection mode is best suited for traditional baking and roasting and you should only use one shelf at a time, otherwise the heat distribution will be uneven. You can balance the amount of heat between the top and the bottom of the dish by selecting a different shelf height. If you want more heat at the top of the dish place the dish on the top or second shelf. For more heat at the bottom of the dish, place the dish on third or fourth shelf.

Delicate cooking mode

When set to Delicate cooking mode, the bottom element and the fan will operate. This mode is suitable for pastries, cakes and non-dry sweets in baking tins or moulds that require heat from the bottom.

Top heat mode

When set to Top heat mode, the top heating element operates. This mode can be used to brown food at the end of cooking.

Grill mode

Select 'Grill' mode with cooking mode selection knob and turn cooking temperature selection knob to '**Max**'. When set to Grill mode, the top inner element operates. The extremely high and direct temperature of the grill makes it possible to brown the surface of meats and roasts while locking the juices in to keep them tender. Grill mode can also be used for dishes that require a high temperature on the surface such as beef steaks, veal, rib steak, filets, hamburgers, etc.

Grill food with the oven door closed (when not using fan).

Use and Care

Fan assisted grill mode

Select 'Fan Assisted Grill' mode with cooking mode selection knob and turn cooking temperature selection knob to the desired temperature setting. When set to Fan Assisted Grill mode, the top inner element and the fan operate. This mode increases the circulation of air throughout the oven, which helps prevent food from burning on the surface, allowing the heat to penetrate right into the food. Particularly suitable for kebabs made with meats and vegetables, sausages, ribs, lamb chops, chicken, quail, pork chops, fish steaks, stuffed cuttlefish etc.

In Fan Assisted Grill mode, grill with the oven door closed.

Fan forced mode

When set to 'Fan Forced' mode, the fan element and the fan operate providing a delicate heat distributed uniformly throughout the oven.

This mode is ideal for baking and cooking delicate foods on multiple shelves, especially cakes that need to rise such as cream puffs and for certain tartlets, sweet or savoury biscuits, savoury puffs, swiss rolls and small portions of vegetables, etc.

Defrost mode

When set to 'Defrost' mode, the fan located at the back of the oven circulates room temperature air around the food. This is recommended for the defrosting of all types of food, but in particular for delicate types of food which do not require heat, for example: ice cream cakes, cream or custard desserts, fruit cakes, etc. By using 'Defrost' mode, the defrosting time is approximately halved.

Use and Care

3 BUTTON DIGITAL CLOCK

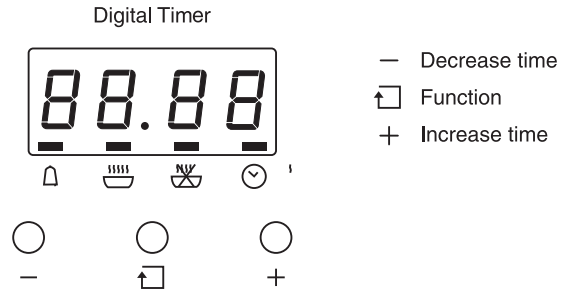

This model has a digital display, 24hr clock with 3 control buttons. When the power is connected, the screen displays '12:00' and the bar above the ⏻ symbol.

Adjusting the digital clock

To set the correct time, press the + or - button to advance forward or backward until the correct time is displayed. After 5 seconds it will start automatically or you can press the function button to make it work.



Manual operation setting



Press the function button to select manual operation.

Use and Care



Automatic setting



Automatic setting of the oven allows you to select the end time, cooking time, temperature and cooking mode. The oven will switch on, cook according to the selected cooking mode and temperature and then switch off automatically.

1. Press the function button repeatedly until the bar above  flashes, then press + or - button to set the time frame for baking.
2. Press the function button repeatedly until the bar above  flashes and then press + or - button to set the time to switch off.
3. Set cooking temperature and cooking mode by turning the thermostat knob and selector knob.



After these settings, the bars above  and  will flash, indicating that the automatic cooking feature of the oven is set.

For example: if cooking time takes 45 minutes and you want it to finish at 14:00:

1. Press the function button repeatedly until the bar above  flashes and set the cooking time 45 minutes.
2. Press the function button repeatedly until the bar above  flashes and set the finish time to 14:00.

After the above setting, the current time is displayed and the bars above  and  will flash indicating that the automatic cooking feature is set. When the clock displays 13:15, the oven will start cooking automatically. While cooking the bar will flash.

Timer

The digital countdown timer can be set up to 23 hours and 59 minutes maximum. To set the timer, press the function button repeatedly until the bar above  is displayed. Once the function button is released, the current time is displayed and the bar above  flashes. When the function button is pressed the remaining stop the alarm, press any time is displayed. When the set time is reached,  disappears and the alarm will ring. To button.

Note: After pressing the function button, timer settings should be done within 5 seconds.

In case of a power failure, all settings including the time display will be lost. When the power is returned, the bar above  and '12:00' will be displayed.

Use and Care

The oven light

Set cooking mode selection knob to  symbol to switch on the oven light/s. The oven light/s stay on when the oven is operating.

Cooling ventilation



In order to cool down the exterior of the appliance, this model is equipped with a cooling fan, which switches on automatically. When the cooling fan is on, you will notice a flow of air exiting between the oven door and the control panel.

Note: When cooking is finished, the cooling fan continues to operate until the oven cools down and then switches off automatically.

PRACTICAL COOKING ADVISE

The oven offers a wide range of settings which allow you to cook any type of food in the best possible way. With time you will learn to make the best use of this versatile cooking appliance and the following directions are only a guideline which may be varied according to your own personal experience.

Preheating

If the oven needs to be preheated, the 'Convection' mode  or 'Fan Forced' mode  should be selected. These are the most efficient modes, which will reach the desired temperature as quickly as possible using the least amount of energy.

Once the food has been placed in the oven, the desired cooking mode should then be selected.

Multi shelf cooking

If you want to cook food on several shelves, select the 'Fan Forced' mode  as this is the only cooking mode that allows you to do so.

When cooking delicate foods on more than one shelf, use the 'Fan Forced' mode. This mode allows you to cook on 3 shelves at the same time. Refer to the 'Cooking Guide' table.

Use and Care

Using the grill

This multi-function oven has 2 different grilling modes.

Use the 'Grill' mode  with the oven door **closed**, place the food on the centre of the grill pan, insert and fit the grill pan on either the 3rd or 4th shelf from the bottom. Note: only the central part of the top heating element operates for grilling.

When using 'Grill' mode, we recommend you set the thermostat to the highest setting. However, this does not mean you cannot use lower temperatures, simply adjust the thermostat knob to the desired temperature.

Use 'Fan assisted grill' mode  with the oven door **closed**. This mode is very useful for grilling foods rapidly, as the distribution of heat by the fan makes it possible not only to brown the surface, but also to cook the bottom of the food. It can also be used for browning foods at the end of the cooking process, such as adding that gratin finish to pasta bakes for example.

When using 'Fan assisted grill' mode, place the food on the 2nd or 3rd oven shelf from the bottom, then place a dripping-pan on the 1st rack from the bottom to prevent fat and grease from dripping onto the oven floor. We recommend you set the thermostat to 200°C, as it is the most efficient temperature for 'Fan assisted grill' mode. However, this does not mean you cannot use lower temperatures, simply adjust the thermostat knob to the desired temperature.

Important: for best results and to save energy, always use the 'Fan assisted grill' with the oven door **closed**.

Use and Care

Baking cakes

When baking cakes, always place them in a preheated oven. Make sure you wait until the oven has been preheated thoroughly (the indicator light will turn off). To prevent heat loss and the cake from dropping, do not open the oven door during baking.

In general...

... if pastry is too dry

Increase the temperature by 10°C and reduce the cooking time.

... if pastry has dropped

Use less liquid or lower the temperature by 10°C.

... if pastry is too dark on top

Place it on a lower shelf, lower the temperature, and increase the cooking time.

... if cooked well on the inside but sticky on the outside

Use less liquid, lower the temperature, and increase the cooking time.

... if the pastry sticks to the pan

Grease the pan well and sprinkle it with a dusting of flour or use greaseproof paper.

... if I used multi shelf cooking and one shelf is more cooked

Use a lower temperature setting next time. It is not necessary to remove the food from all the racks at the same time.

Use and Care

Cooking pizza

For best results when cooking pizza:

- Preheat the oven for at least 10 minutes.
- Use a light aluminum pizza pan, placing it on the shelf supplied with the oven. Don't use the dripping pan since this will extend the cooking time, making it difficult to get a crispy crust.
- Do not open the oven door frequently while the pizza is cooking;
- If the pizza has a lot of toppings (three or four), we recommend you add the mozzarella cheese on top halfway through the cooking process.
- For best results, only use one shelf at a time, but if you want to cook on two shelves, use the 2nd and 4th racks from the bottom with a temperature of 220°C and swap them halfway through cooking.

Cooking fish and meat

When cooking white meat, fowl and fish, use a temperature setting from 180°C to 200°C.



For red meat that you want well done on the outside while tender and juicy in the inside, it is best to start with a high temperature setting (200°C-220°C) for a short time, then turn the oven down afterwards.

In general, the larger the roast, the lower the temperature setting. Place the meat on the centre of the shelf and place the dripping pan beneath it to catch the fat.

Make sure that the shelf is inserted so that it is in the centre of the oven. If you would like to increase the amount of heat from below, use a lower shelf height. For savoury roasts (especially duck and wild game), dress the meat with lard or bacon on the top.

Use and Care

Cooking guide



Selector knob setting	Food to be cooked	Level from below	Temperature (°C)	Time in minutes(*)
 Traditional cooking	First courses			
	Lasagne	2-3	210-230	30
	oven-baked pasta	2-3	210-230	40
	MEAT			
	Roast veal	2	175-200	30-40/kg
	Roast beef	2	210-240	30-40/kg
	Roast pork	2	170-200	30-40/kg
	Chicken	2	170-200	45-60
	Duck	2	170-200	45-60
	Goose-turkey	2	140-170	45-60
Rabbit	2	170-200	50-60	
Leg of lamb	1	170-200	15/kg	
Roast fish	1-2	170-200	According to dimensions	
Pizza	1-2	210-240	40-45	
DESSERTS				
Meringue	1-2	50-70	60-90	
Short pastry	1-2	170-200	15-20	
Ciambella	1-2	165	35-40	
Savoyards	1-2	150	30-50	
Brioche	1-2	170-200	40-45	
Fruit cake	1-2	170-200	20-30	
	Browning food to perfect cooking	3-4	15	220

(*) With preheated oven

Selector knob setting	Food to be cooked	Level from below	Temperature (°C)	Time in minutes
 Fan forced cooking	First courses			
	Lasagne	2	190-210	20-25
	Oven-baked pasta	2	190-210	25-30
	Creole rice	2	190-220	20-25
	MEAT			
	Roast veal	2	150-170	65-90
	Roast pork	2	150-160	70-100
	Roasted beef	2	160-170	65-90
	Fillet of beef	2	160-180	35-45
	Fillet lamb	2	130-150	100-130
	Roast beef	2	170-180	40-45
	Roast chicken	2	170	70-90
	Roast duck	2	160-170	100-160
	Roast turkey	2	150-160	160-240
	Roast rabbit	2	150-160	80-100
	Roast hare	2	160-170	30-50
	Roast pigeon	2	140-170	15-25
	Fish	2-3	150-170	According to dimensions
	Pizza	2-3	210-240	30-50
	DESSERTS(PASTRIES)			
Ciambella	2-3	150-170	35-45	
Fruit cake	2-3	170-190	40-50	
Sponge-cake	2-3	190-220	25-35	
Brioche	2-3	160-170	40-60	
Strudel	1-2	150	25-35	
Savoyard pudding	2-3	160-170	30-40	
Bread	2-3	190-210	40	
Toast	1-2	220-240	7	

Use and Care

Cooking guide (cont'd)

Selector knob setting	Food to be cooked	Level from below	Time in minutes	
			First surface	Second surface
Grilling  	Pork chops	4	7-9	5-7
	Fillet of pork	3	9-11	5-9
	Fillet of beef	3	9-11	9-11
	Liver	4	2-3	2-3
	Veal Escalopes	4	7-9	5-7
	Half chicken	3	9-14	9-11
	Sausages	4	7-9	5-6
	Meat-balls	4	7-9	5-6
	Fish fillets	4	5-6	3-4
	Toast	4	2-4	2-3

Note: Cooking times are approximate and may vary according to personal taste. When cooking using the grill or fan assisted grill, the dripping pan must always be placed on the 1st oven shelf from the bottom.

Cooktop cleaning and maintenance

Switch off your appliance before cleaning.

The ceramic glass should be regularly cleaned, preferably immediately after each use, once the residual heat warnings have switched off.

Smudges from pans with an aluminum bottom can be easily cleaned off with a cloth dampened in vinegar.

Remove any burnt residues immediately after cooking, rinse with water and wipe dry with a clean cloth.

Never use abrasive or corrosive detergents, cleaning powders, oven sprays, spot-removers, steel wool or scourers.

DO NOT use a steam cleaner to clean the appliance.

Use and Care

Oven cleaning and maintenance

Before cleaning your oven or performing maintenance, make sure that the cooking mode selection knob and the cooking temperature selection knob is set to 'OFF'. To extend the life of your oven, it must be cleaned frequently.

The inside of the oven should preferably be cleaned immediately after use, when it is still warm (but not hot), with warm water and soap. The soap should be rinsed away and the interior dried thoroughly. Avoid using abrasive detergents, scourers acidic cleaners such as lime scale remover, etc. as these could damage the enamel. If stains are particularly tough to remove, use cleaners specifically recommended to clean ovens and follow the instructions provided with the cleaner. **Never use a steam cleaner or caustic oven cleaners for cleaning inside the oven.**

If you operate your oven for an extended period of time, or if you are cooking dishes that contain a lot of water, condensation may form on the oven door. Dry it using a soft cloth and try reducing the cooking temperature.

There is a rubber seal surrounding the oven opening which is necessary to ensure the correct operation of the oven. Check the condition of this seal on a regular basis. If necessary, clean it but avoid using abrasive products or objects to do so. Should it become damaged, please contact Technika Service Department. We recommend you avoid using the oven until it has been repaired.

Never place anything (including foil and oven trays) on the bottom of the oven when it is in operation because this could damage the enamel.

Clean the glass door using non-abrasive products or sponges and dry it with a soft cloth.

Do not use abrasive cleaners or sharp metal scrapers to clean the oven door glass since they can scratch the surface, which may result in shattering the glass.

Use only non caustic oven cleaners purchased from hardware stores or supermarkets.

Use and Care

How to remove the oven door

You can remove the oven door for better access to the oven when cleaning. There are 2 styles of oven door so you should first identify which style you have. Proceed as follows for each style:

Oven door style 1:

- Open the door fully.
- Lift up and turn the small hooks located on the two hinges.
- Grip the door on the two external sides, shut it slowly but not completely.
- Pull the door up towards you, lifting it out of the oven frame.
- To replace the door, use the reverse procedure.

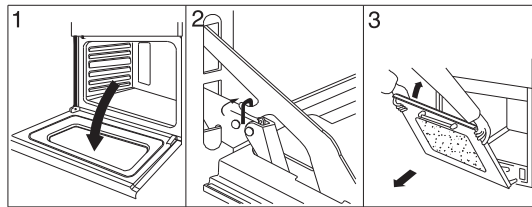

Oven door style 2:

- Open the door fully.
- Lift up and turn the small hooks situated on the two hinges.
- Grip the door on the two external sides and close it approximately half way. Unlock the door by pressing on the clamps 'A'.
- Pull the door up towards you, lifting it out of the oven frame.
- To replace the door, use the reverse procedure.

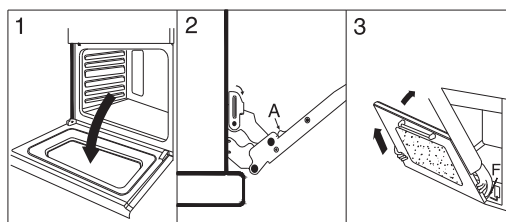

Use and Care

Replacing the oven lamps

WARNING: Ensure that the appliance is switched off before replacing the lamp to avoid the possibility of electric shock.

Remove the glass cover of the lamp-holder as shown below.

Remove the lamp and replace with a lamp resistant to high temperatures (300°C) with the following characteristics:

- Voltage: 220-240V
- Wattage: 25W
- Type: E 14

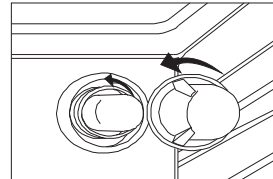

Replacement lamps are available from Euromaid. Replace the glass cover and reconnect the oven to the mains power supply.

Troubleshooting

Problem	Possible reason	Solution
The cooker doesn't work.	The cooker is not wired in or switched on at the wall.	Check that the main switch/circuit breaker/safety switch is turned on.
	There is a power failure.	Check power supply.
The results of cooking are unsatisfactory.	Temperature is too high or too low.	Consult Practical Cooking Advice.
	Wrong type of pot/pan.	
	Cooking time is incorrect.	
The cooker smokes.	The hob or oven is dirty.	Clean the hob or oven once cooking is finished. Let it cool first.
	Food has spilled over.	Clean hob or oven floor, then use a larger pan or baking dish or grill tray.
The oven does not come on during automatic cooking.	Timed cooking programming - error	Check the Timer instructions.

In case the appliance fails to operate correctly, contact Euromaid.

Use and Care

Service and parts

Before leaving the factory, this appliance was tested and adjusted by specialist skilled staff to give the best operating results. Any subsequent necessary repairs or adjustments must be carried out with the greatest care and attention by authorised personnel. For this reason, we strongly advise you contact the Euromaid Service Center, specifying the nature of the problem, the model of the equipment and the serial number. This data is provided on the data label adhered to the base of the appliance and on the duplicate data label. Always use original Euromaid spare parts.

Warranty

Your new appliance is covered by a warranty. The details of your warranty conditions are on your Warranty Card supplied with the appliance. Keep the physical receipt which documents your purchase of the appliance and purchase date as you will need to show this for any Warranty repairs. Warranty cannot be claimed without proof of purchase.

Disposal

By ensuring this product is disposed of correctly, you will help prevent potential negative consequences for the environment and human health, which could otherwise be caused by inappropriate waste handling of this product.



The symbol on the product indicates that this product may not be treated as household waste. Instead it shall be handed over to the applicable collection point for the recycling of electrical and electronic equipment.

Disposal must be carried out in accordance with local environmental regulations for waste disposal.

For more detailed information about treatment, recovery and recycling of this product, please contact your local city council office.

Installation

Technical data

Electricity supply 220-240V AC (50-60Hz)

Electrical Features:

Cooktop burner - A (single cooking zone): 1300W

Cooktop burner - B (dual cooking zone): 2395W/1088W

Cooktop burner - C (single cooking zone): 1960W

Cooktop burner - D (single cooking zone): 2500W

Cooktop burner - E (dual cooking zone): 1850W/760W

Cooktop burner - F (dual cooking zone): 2180W/1200W

Oven light: 2×25W

Upper heating element: 2400W

Bottom heating element: 1960W

Grill heating element: 3160W

Circular heating element: 2×1690W

Motor ventilator: 2×30W

Cooling fan: 20W

Maximum rating: 12650W

Inner dimensions of the oven:

Width: 69 cm Depth: 43 cm Height: 37 cm

Inner Volume of the oven: 105 litres

Voltage and Frequency of Power Supply:

220-240V AC (50-60Hz)

Installation

Instructions for installation



This appliance shall be installed only by authorised persons and in accordance with the manufacturer's installation instructions, local regulations, municipal building codes, electrical wiring regulations, and any other statutory regulations.

IMPORTANT: Installation, assembly and gas/electrical connections must be carried out by authorised personnel.

Data Label - Make sure that the voltage and capacity of the power supply are in accordance with the data label located in the storage drawer or the rear panel of the appliance. **Do not remove the data label for any reason.**

Before any procedure, it is important to check that the appliance is DISCONNECTED from the electrical mains. The Manufacturer declines all responsibility for any damage deriving from installations in breach of the regulations in force or from failure to comply with these installation instructions.

Installation

Dimensions

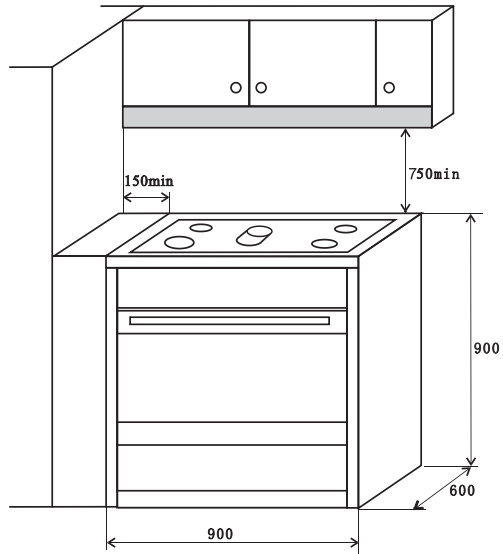

Combustible Surfaces

Any adjoining wall surface must be 150mm minimum distance from the appliance. Make sure there is a minimum of 650 mm between the hob and any shelf, Rangehood or exhaust fan that may be installed directly above the hob.

Zero clearance is permitted on the side and rear adjoining surfaces below the maintop.

Installation

Anti-tilting chain

The cooker is supplied with two chains which are connected to the rear left and right of the appliance. The chains should be connected to the wall directly behind the chains as low as possible to prevent the appliance from tilting forward. If the appliance is installed between two cupboards, drill a hole on each side of the cupboards, pass the chains through the holes and anchor the chains within each cupboard. Ensure the chain connections are strong enough to support the weight of the appliance and taught to prevent it from tilting forward.

WARNING: In order to prevent accidental tipping of the appliance, for example a child climbing onto the open oven door, the stabilising means must be installed. Ensure the chains are correctly anchored to prevent the appliance from tilting forward.

MAKE SURE THE ANTI-TILTING CHAINS ARE TAUGHT WHEN ANCHORED TO PREVENT THE APPLIANCE TILTING.

Installation

Electrical connection

The appliance is usually supplied fitted with a power cord. The supply cable should be positioned so that it does not reach a temperature of more than 75°C along its entire length.

Connect the cable directly to the mains, connection to the electricity supply must be made by an authorised person in accordance with the Wiring Rules. The installation must include a suitable isolating switch with a minimum contact opening of 3mm between the appliance and the mains. The isolating switch should be sized according to the load on the data label and should comply with current regulations (the earth wire should not be interrupted by the circuit breaker).

Before making the connection check that:

- the switch, wiring and electrical system can support the appliance load (see data plate);
- the power supply system has an efficient earthing connection which complies with the provisions of current regulations;
- the power outlet or omnipoar circuit-breaker is easily accessible once the cooker has been installed.

Replacing the power supply lead

If the supply cord or plug is damaged, it must be replaced by the manufacturer or its service agent or a similarly qualified person in order to avoid hazard.

Before leaving

When the installation is complete, operate each element and the oven to check that they are operating correctly. Make sure the indicator lights are also operating correctly.

When satisfied with the operation, please instruct the user on the correct method of operation. In case the appliance fails to operate correctly after all checks have been carried out, please call the Euromaid Service Centre.

Euromaid

distributed by **Home Appliances Pty Ltd**

20 Carlotta Street
Artarmon, NSW 2064

T: 02 9958 3111

F: 02 9958 3555

W: euromaid.com.au

Service: 1800 805 300

Home Appliances reserves the right to make changes to specifications and dimensions without notice.