

# Euromaid

**installation & operating  
instructions and cooking  
guidance**

**Oven**

**Model CS 60  
CW 60**

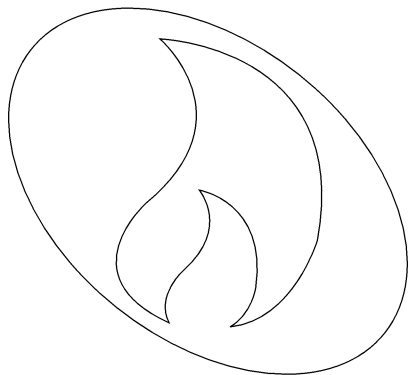

*get the **best** from your new cooker*



## **Please read this manual first.**

Dear Customer,

We would like you to obtain best performance with your product that has been manufactured in modern facilities and passed through strict quality control procedures.

Therefore, we advise you to read through this User Manual carefully before using your product and keep it for future reference. If you hand over the product to someone else, deliver the User Manual as well.

## **The User Manual will help you use the product in a fast and safe way.**

- Read the User Manual before installing and operating the product.
- You must strictly observe the safety instructions.
- Keep this User Manual within easy reach for future reference.
- Also read other documents supplied with the product.

Remember that this User Manual may also be applicable for several other models.

Differences between models are explicitly identified in the manual.

## **Explanation of symbols**

Throughout this User Manual the following symbols are used:

 Important information or useful hints about usage.

 Warning for hazardous situations with regard to life and property.

 Warning for electric shock.

 Warning for risk of fire.

 Warning for hot surfaces.

# Table of Contents

---

## **1 General information 4**

Overview .....	4
Technical specifications .....	5
Accessories .....	6

## **2 Important safety instructions 8**

General safety .....	8
Intended use .....	9
Safety for children .....	9
Safety when working with electricity	10

## **3 Installation 11**

Before installation .....	11
Installation and connection .....	12
Disposal .....	14
Disposing of packaging material .....	14
Future Transportation .....	14
Disposing of the old product .....	14

## **4 Preparation 16**

Tips for saving energy .....	16
Initial use .....	16
First cleaning of the appliance .....	16
Initial heating .....	16

## **5 How to use the hob 18**

General information about cooking .....	18
Using the hobs .....	19

## **6 How to operate the oven 20**

General information on baking, roasting and grilling .....	20
How to operate the electric oven .....	21
Operating modes .....	21
Cooking times table .....	22
How to operate the grill .....	24
Cooking times table for grilling .....	24

## **7 Maintenance and care 25**

General information .....	25
Cleaning the hob .....	25
Cleaning the control panel .....	26
Cleaning the oven .....	26
Removing the oven door .....	26
Replacing the oven lamp .....	27

## **8 Troubleshooting 28**

# 1 General information

## Overview

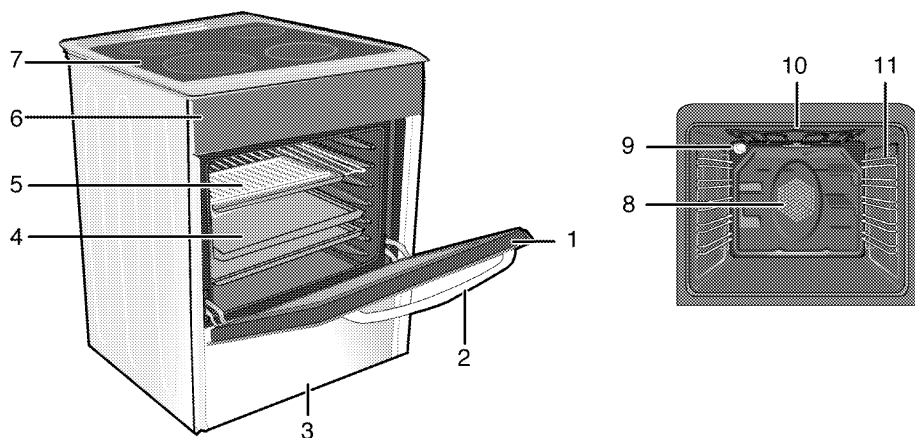

- |   |               |    |                                |
|---|---------------|----|--------------------------------|
| 1 | Front door    | 7  | Burner plate                   |
| 2 | Handle        | 8  | Fan motor (behind steel plate) |
| 3 | Bottom part   | 9  | Lamp                           |
| 4 | Tray          | 10 | Grill heating element          |
| 5 | Wire shelf    | 11 | Shelf positions                |
| 6 | Control panel |    |                                |

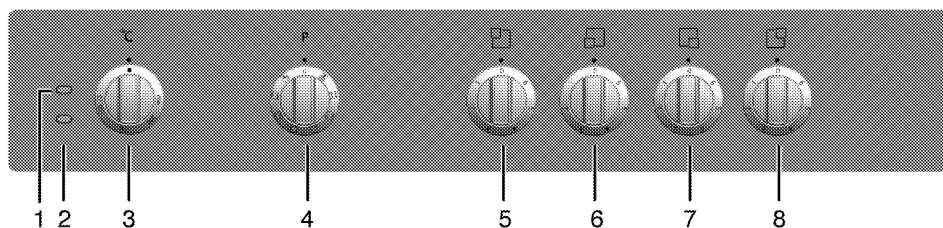

- |   |  |   |  |
|---|--|---|--|
| 1 | Warning lamp                           | 6 | Single-circuit cooking plate Front left  |
| 2 | Thermostat lamp                        | 7 | Single-circuit cooking plate Front right |
| 3 | Thermostat knob                        | 8 | Single-circuit cooking plate Rear right  |
| 4 | Function knob                          |   |  |
| 5 | Single-circuit cooking plate Rear left |   |  |

## Technical specifications

<b>GENERAL</b>	
External dimensions (height / width / depth)	850 mm/600 mm/600 mm
Voltage / frequency	220-240V ~ 50 Hz
Total power consumption	8.2 kW
Fuse	min. 16 A x 3
Cable type / section	H05VV-FG 3 x 2,5 mm <sup>2</sup>
Cable length	max. 2 m
<b>HOB</b>	
<b>Burners</b>	
Rear left	<b>Single-circuit cooking plate</b>
Dimension	140 mm
Power	1200 W
Front left	<b>Single-circuit cooking plate</b>
Dimension	180 mm
Power	1700 W
Front right	<b>Single-circuit cooking plate</b>
Dimension	140 mm
Power	1200 W
Rear right	<b>Single-circuit cooking plate</b>
Dimension	180 mm
Power	1700 W
<b>OVEN/GRILL</b>	
Main oven	<b>Multifunction oven</b>
Energy efficiency class <sup>#</sup>	A
Inner lamp	15-25 W
Grill power consumption	2.2 kW

<sup>#</sup> Basics: Information on the energy label of electrical ovens is given in accordance with the EN 50304 standard. Those values are determined under standard load with bottom-top heater or fan assisted heating (if any) functions.

Energy efficiency class is determined in accordance with the following prioritization depending on whether the relevant functions exist on the product or not. 1-Cooking with eco-fan, 2- Turbo slow cooking, 3- Turbo cooking, 4- Fan assisted bottom/top heating, 5-Top and bottom heating.



### Important

Technical specifications may be changed without prior notice to improve the quality of the product.



### Important

Figures in this manual are schematic and may not exactly match your product.



### Important

Values stated on the product labels or in the documentation accompanying it are obtained in laboratory conditions in accordance with relevant standards. Depending on operational and environmental conditions of the product, these values may vary.

## Accessories



### Important

Accessories supplied can vary depending on the product model. Not every accessory described in the user manual may exist on your product.

### Oven tray

Used for pastries, frozen foods and big roasts.

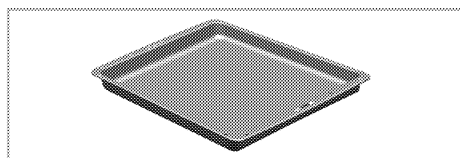

### Deep tray

Used for pastries, large roasts, juicy dishes, and for collecting the fat while grilling.

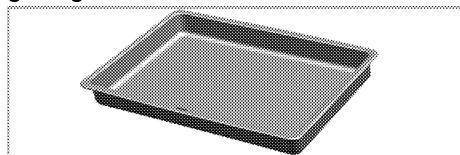

### Cake tray

Used for pastries such as cookies and biscuits.

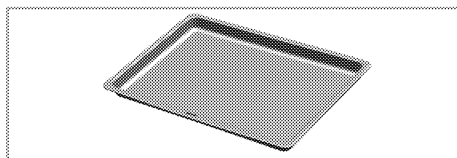

### Small oven tray

Used for small portions. This oven tray is placed onto the wire shelf.

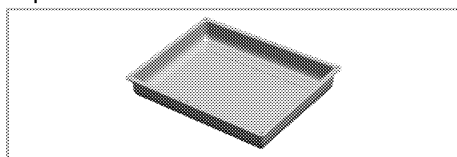

### Wire Shelf

Used for roasting and for placing the food to be baked, roasted or cooked in casserole dishes to the desired rack.

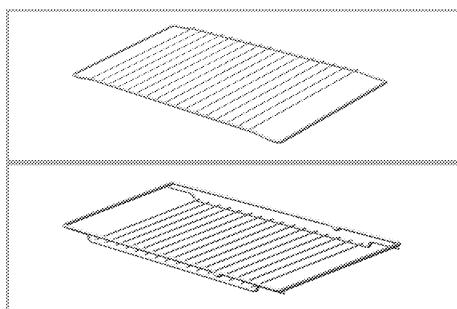

### Placing the wire shelf and tray onto the telescopic racks properly

Telescopic racks allow you to install and remove the trays and wire shelf easily.

When using the tray and wire shelf with telescopic racks, make sure that the pins at the rear section of the telescopic rack stands against the edges of the wire shelf and tray.

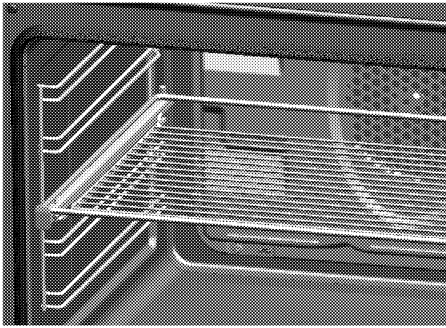
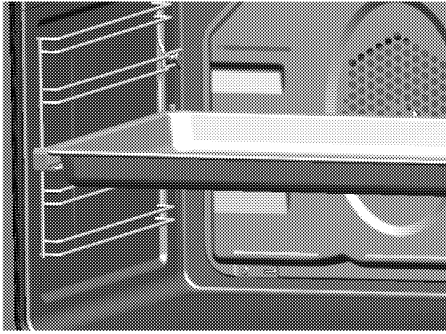

### Splash back assembly

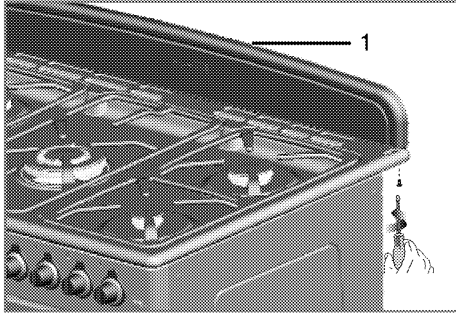

- 1 Splash back assembly
- Remove the splash back assembly from the packaging taking care to retain the two nuts and bolts required for fixing the splash back to the product. Position the splash back assembly as indicated. Secure the splash back assembly to the hob with the nuts and bolts provided. Do not over tighten the

bolts in order to avoid any damages to the hob or splash back assembly.

### Splash back assembly

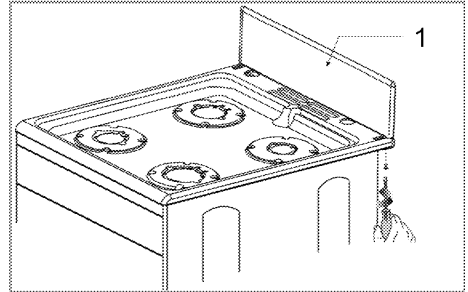

- 1 Splashback
1. Please take splashback and package of screws, nuts, fillers form warmer drawer
2. Place splashback according to the drawing, place nut inside splashback on to the hole, screw the splashback to the burner's plate with screw form under burner plate

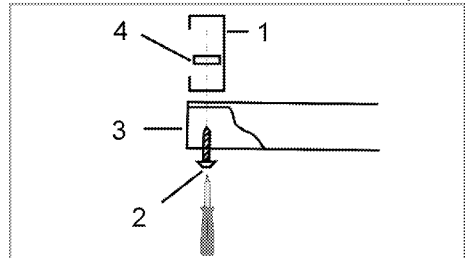

- 1 Splashback
- 2 Screw
- 3 Burner plate
- 4 Nut
3. If you don't want to install splashback on to your cooker, you can place fillers to the holes.
4. Do not overtighten the screws as damage to the hob or splashback could occur.



## 2 Important safety instructions

---

This section contains safety instructions that will help you avoid risk of injury and damage. All warranties will become void if you do not follow these instructions.

### General safety

- This product is not intended to be used by persons with physical, sensory or mental disorders or unlearned or inexperienced people (including children) unless they are attended by a person who will be responsible for their safety or who will instruct them accordingly for use of the product.  
Children must be supervised to prevent them from tampering with the product.
- Connect the product to an earthed outlet/line protected by a fuse of suitable capacity as stated in the "Technical specifications" table. Have the earthing installation made by a qualified electrician while using the product with or without a transformer. Our company shall not be liable for any problems arising due to the product not being earthed in accordance with the local regulations.
- If the supply cord is damaged, it must be replaced by the manufacturer, its service agent or similiary qualified persons in order to avoid a hazard.
- Do not operate the product if it is defective or has any visible damage.
- Do not carry out any repairs or modifications on the product. However, you may remedy some troubles that do not require any repairs or modifications. See *Troubleshooting, page 28*.
- Never wash down the product with water! There is the risk of electric shock!
- Never use the product when your judgment or coordination is impaired by the use of alcohol and/or drugs.
- Product must be disconnected from the mains during installation, maintenance, cleaning and repair procedures.
- Be careful when using alcoholic drinks in your dishes. Alcohol evaporates at high temperatures and may cause fire since it can ignite when it comes into contact with hot surfaces.
- Do not heat closed tins and glass jars in the oven. The pressure that would build-up in the tin/jar may cause it to burst.
- Do not place any flammable materials close to the product as the sides may become hot during use.
- Do not place baking trays, dishes or aluminium foil directly onto the bottom of the oven. The heat accumulation might damage the bottom of the oven.

- Keep all ventilation slots clear of obstructions.
- Product may be hot when it is in use. Never touch the hot burners, inner sections of the oven, heaters and etc.
- Always use heat resistant oven gloves when putting in or removing dishes into/from the hot oven.
- Do not use the product with front door glass removed or cracked.
- Rear surface of the oven gets hot when it is in use. Make sure that the gas/electrical connection does not contact the rear surface; otherwise, connections can get damaged.
- Do not trap the mains cable between the oven door and frame and do not route it over hot surfaces. Otherwise, cable insulation may melt and cause fire as a result of short circuit.
- Make sure that the product function knobs are switched off after every use.
- Vapour pressure that build up due to the moisture on the hob surface or at the bottom of the pot can cause the pot to move. Therefore, make sure that the oven surface and bottom of the pots are always dry.

	<p><b>Important</b></p> <p><b>The appliance is not intended to be operated by means of an external timer or separate remote control.</b></p>
--	--

## Intended use

This product is designed for domestic use. Commercial use will void the guarantee.

"CAUTION: This appliance is for cooking purposes only. It must not be used for other purposes, for example room heating."

This product should not be used for warming the plates under the grill, drying towels, dish cloths etc. by hanging them on the oven door handles. This product should also not be used for room heating purposes. The manufacturer shall not be liable for any damage caused by improper use or handling errors.

The oven can be used for defrosting, baking, roasting and grilling food.

## Safety for children

- Electrical and/or gas products are dangerous to children. Keep children away from the product when it is operating and do not allow them to play with the product.
- Accessible parts of the appliance will become hot whilst the appliance is in use. Children should be kept away until the product has cooled down.
- **"CAUTION:** Accessible parts may be hot when the grill is in use. Young children should be kept away."
- Do not place any items above the appliance that children may reach for.
- When the door is open, do **not** load any heavy object on it and do

- not** allow children to sit on it. It may overturn or door hinges may get damaged.
- The packaging materials will be dangerous for children. Keep the packaging materials away from children. Please dispose of all parts of the packaging according to environmental standards.

## **SAVE THESE INSTRUCTIONS**

### **Safety when working with electricity**

Defective electric equipment is one of the major causes of house fires.

- Any work on electrical equipment and systems should only be carried out by authorized and qualified persons.
- In case of any damage, switch off the product and disconnect it from the mains. To do this, turn off the fuse at home.
- Make sure that fuse rating is compatible with the product.

### 3 Installation

Product must be installed by a qualified person in accordance with the regulations in force. The manufacturer shall not be held responsible for damages arising from procedures carried out by unauthorized persons which may also void the warranty.



#### Important

Preparation of location and electrical and gas installation for the product is under customer's responsibility.



#### DANGER

The product must be installed in accordance with all local gas and/or electrical regulations.



#### DANGER

**Prior to installation, visually check if the product has any defects on it. If so, do not have it installed.**

Damaged products cause risks for your safety.

#### Before installation

To ensure that critical air gaps are maintained under the appliance, we recommend that this appliance is mounted on a solid base and that the feet do not sink into any carpet or soft flooring.

The kitchen floor must be able to carry the weight of the appliance plus the

additional weight of cookware and bakeware and food.

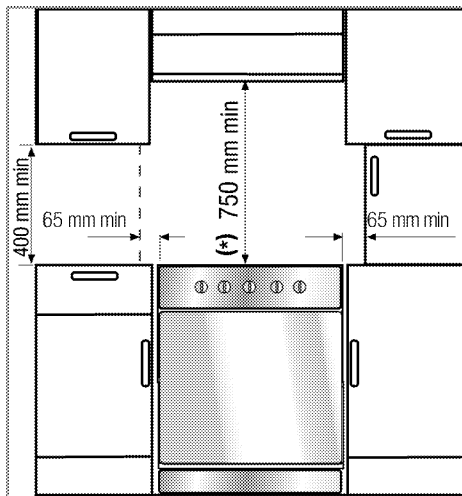

- It can be used with cabinets on either side but in order to have a minimum distance of 400mm above hotplate level allow a side clearance of 65mm between the appliance and any wall, partition or tall cupboard.
- It can also be used in a free standing position. Allow a minimum distance of 750 mm above the hob surface.
- (\*) If a cooker hood is to be installed above the cooker, refer to cooker hood manufacturer' instructions regarding installation height (min 650 mm).
- The appliance corresponds to device class 1, i.e. it may be placed with the rear and **one** side to kitchen walls, kitchen furniture or equipment of any size. The kitchen furniture or equipment on

the **other** side may only be of the same size or smaller.

- Any kitchen furniture next to the appliance must be heat-resistant (100 °C min.).

**i Important**  
The appliance must be secured against overbalancing by using the supplied chain on your oven. Fasten hook (1) to the kitchen wall (5) and connect safety chain (2) to the hook.

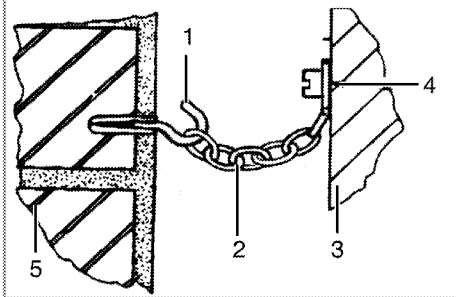

- 1 Hook (is not supplied)
- 2 Safety chain (supplied and mounted to oven)
- 3 Rear of cooker
- 4 Firmly fix chain to cooker rear
- 5 Kitchen wall

## Installation and connection

Product can only be installed and connected in accordance with the statutory installation rules.

**i Important**  
Do not install the appliance next to refrigerators or freezers. The heat emitted by the appliance will lead to an increased energy consumption of cooling appliances.

- Carry the product with at least two persons.
- Product must be placed directly on the floor. It must not be placed onto a base or a pedestal.

**i NOTICE**  
Material damage!  
The door and/or handle must not be used for lifting or moving the appliance.

## Electrical connection

Connect the product to a grounded outlet/line protected by a fuse of suitable capacity as stated in the "Technical specifications" table. Have the grounding installation made by a qualified electrician while using the product with or without a transformer. Our company shall not be liable for any damages that will arise due to using the product without a grounding installation in accordance with the local regulations.

**⚠ DANGER**  
**Risk of electric shock, short circuit or fire by unprofessional installation!**  
The appliance may be connected to the mains supply only by an authorized qualified person and the appliance is only guaranteed after correct installation.



## DANGER

**Risk of electric shock, short circuit or fire by damage of the mains lead!**

The mains lead must not be clamped, bent or trapped or come into contact with hot parts of the appliance.

If the mains lead is damaged, it must be replaced by a qualified electrician.

The mains supply data must correspond to the data specified on the type label of the product. The rating plate is either seen when the door or the lower cover is opened or it is located at the rear wall of the unit depending on the unit type.

Power cable of your product must comply with the values in "Technical specifications" table.



## DANGER

**Risk of electric shock!**

Before starting any work on the electrical installation, please disconnect the appliance from the mains supply.

### Connecting the power cable

1. **If a power cable is not supplied together with your product,** a power cable that you would select from the table (*Technical specifications, page 5*) in accordance with the electrical installation at your home must be connected to your product by following the instructions in cable diagram.

If it is not possible to disconnect all poles in the supply power, a disconnection unit with at least 3 mm

contact clearance (fuses, line safety switches, contactors) must be connected and all the poles of this disconnection unit must be adjacent to (not above) the product in accordance with IEE directives. Failure to obey this instruction may cause operational problems and invalidate the product warranty.



## NOTICE

Additional protection by a residual current circuit breaker is recommended.

2. Open the terminal block cover with a screwdriver.
3. Insert the power cable through the cable clamp below the terminal and secure it to the main body with the integrated screw on cable clamping component.
4. Connect the cables according to the supplied diagram.

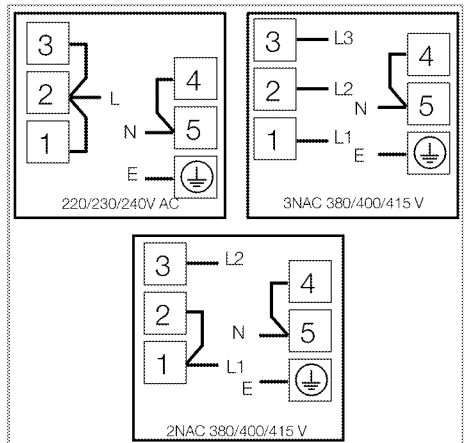

5. After completing the wire connections, close the terminal block cover.
6. Route the power cable so that it will not contact the product and get

squeezed between the product and the wall.



### NOTICE

Power cable must not be longer than 2 m because of safety reasons.

- Push the product towards the kitchen wall.
- Hook safety chain.
- **Adjusting the feet of oven**  
Vibrations during use may cause cooking vessels to move. This dangerous situation can be avoided if the product is level and balanced.  
For your own safety please ensure the product is level by adjusting the four feet at the bottom by turning left or right and align level with the work top.

### Final check

1. Reconnect the product to the mains.
2. Open gas supply.

## Disposal

### Disposing of packaging material

Packaging materials are dangerous to children. Keep packaging materials in a safe place out of reach of children. Packaging materials of the product are manufactured from recyclable materials. Dispose of them properly and sort in accordance with recycled waste instructions. Do not dispose of them with normal domestic waste.

## Future Transportation

- Keep the product's original carton and transport the product in it. Follow the instructions on the carton. If you do not have the original carton, pack the product in bubble wrap or thick cardboard and tape it securely.
- To prevent the wire grill and tray inside the oven from damaging the oven door, place a strip of cardboard onto the inside of the oven door that lines up with the position of the trays. Tape the oven door to the side walls.
- Do not use the door or handle to lift or move the product.



### NOTICE

Do not place other items on the top of the appliance. The appliance must be transported upright.



### Important

Check the general appearance of your product for any damages that might have occurred during transportation.

### Disposing of the old product



Dispose of the old product in an environmentally friendly manner. This equipment bears the selective sorting symbol for waste electrical and electronic equipment (WEEE). This means that this equipment must be handled pursuant to European Directive 2002/96/EC in order to be recycled or dismantled to minimize its

impact on the environment. For further information, please contact local or regional authorities.

Refer to your local dealer or solid waste collection centre in your area to learn how to dispose of your product.

Before disposing of the product, cut off the power cable plug and make the door lock (if any) unusable to avoid dangerous conditions to children.



## 4 Preparation

### Tips for saving energy

The following information will help you to use your appliance in an ecological way, and to save energy:

- Use dark coloured or enamel coated cookware in the oven since the heat transmission will be better.
- While cooking your dishes, perform a preheating operation if it is advised in the user manual or cooking instructions.
- Do not open the door of the oven frequently during cooking.
- Try to cook more than one dish in the oven at the same time whenever possible. You can cook by placing two cooking vessels onto the wire shelf.
- Cook more than one dish one after another. The oven will already be hot.
- You can save energy by switching off your oven a few minutes before the end of the cooking time. Do not open the oven door.
- Defrost frozen dishes before cooking them.
- Use pots/pans with cover for cooking. If there is no cover, energy consumption may increase 4 times.
- Select the burner which is suitable for the bottom size of the pot to be used. Always select the correct pot size for your dishes. Larger pots require more energy.

- Pay attention to use flat bottom pots when cooking with electric hobs.  
Pots with thick bottom will provide a better heat conduction. You can obtain energy savings up to 1/3.
- Vessels and pots must be compatible with the cooking zones. Bottom of the vessels or pots must not be smaller than the hotplate.
- Keep the cooking zones and bottom of the pots clean. Dirt will decrease the heat conduction between the cooking zone and bottom of the pot.
- For long cookings, turn off the cooking zone 5 or 10 minutes before the end of cooking time. You can obtain energy savings up to 20% by using the residual heat.

### Initial use

#### First cleaning of the appliance



#### NOTICE

The surface may get damaged by some detergents or cleaning materials.

Do not use aggressive detergents, cleaning powder/cream or any sharp objects.

1. Remove all packaging materials.
2. Wipe the surfaces of the appliance with a damp cloth or sponge and dry with a cloth.

### Initial heating

Heat up the product for about 30 minutes and then switch it off. Thus,

any production residues or layers will be burnt off and removed.



### **WARNING**

#### **Hot surfaces may cause burns!**

Do not touch the hot surfaces of the appliance. Use oven gloves. Keep children away from the appliance.

### **Electric oven**

1. Take all baking trays and the wire grill out of the oven.
2. Close the oven door.
3. Select Static position.
4. Select the highest grill power; See .
5. Operate the oven for about 30 minutes.

6. Turn off your oven; See

### **Grill oven**

1. Take all baking trays and the wire grill out of the oven.
2. Close the oven door.
3. Select the highest grill power; see *How to operate the grill, page 24*.
4. Operate the grill about 30 minutes.
5. Turn off your grill; see *How to operate the grill, page 24*



### **Important**

Smell and smoke may emit during first heating. Ensure that the room is well ventilated.

## 5 How to use the hob

### General information about cooking



**DANGER**  
**Risk of fire by overheated oil!**  
When you heat oil, do not leave it unattended.  
**Never try to extinguish the fire with water!** When oil has caught fire, immediately cover the pot or pan with a lid. Switch off the hob if safe to do so and phone the fire service.

- Before frying foods, always dry them well and gently place into the hot oil. Ensure complete thawing of frozen foods before frying.
- Do not cover the vessel you use when heating oil.
- Place the pans and saucepans in a manner so that their handles are not over the hob to prevent heating of the handles. Do not place unbalanced and easily tilting vessels on the hob.
- Do not place empty vessels and saucepans on cooking zones that are switched on. They might get damaged.
- Operating a cooking zone without a vessel or saucepan on it will cause damage to the product. Turn off the cooking zones after the cooking is complete.
- As the surface of the product can be hot, do not put plastic and aluminum vessels on it. Clean any melted such materials on the surface immediately.

Such vessels should not be used to keep foods either.

- Use flat bottomed saucepans or vessels only.
- Put appropriate amount of food in saucepans and pans. Thus, you will not have to make any unnecessary cleaning by preventing the dishes from overflowing.

Do not put covers of saucepans or pans on cooking zones.

Place the saucepans in a manner so that they are centered on the cooking zone. When you want to move the saucepan onto another cooking zone, lift and place it onto the cooking zone you want instead of sliding it.

#### Tips about glass ceramic hobs

- Glass ceramic surface is heatproof and is not affected by big temperature differences.
- Do not use the glass ceramic surface as a place of storage or as a cutting board.
- Use only the saucepans and pans with machined bottoms. Sharp edges create scratches on the surface.
- Do not use aluminum vessels and saucepans. Aluminum damages the glass ceramic surface.

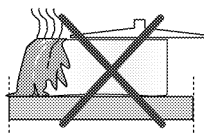

Spills may damage the glass ceramic surface and cause fire.

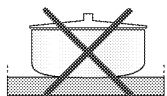

Do not use vessels with concave or convex bottoms.

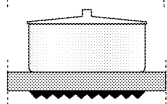

Use only the saucepans and pans with flat bottoms. They ensure easier heat transfer.

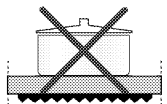

If the diameter of the saucepan is too small, energy will be wasted.

## Using the hobs

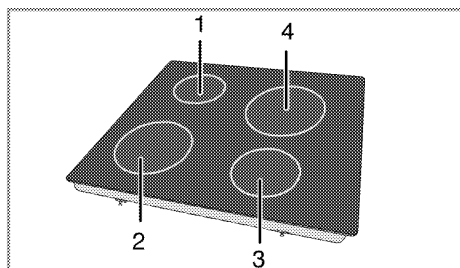

- 1 Single-circuit cooking plate 14-16 cm
  - 2 Single-circuit cooking plate 18-20 cm
  - 3 Single-circuit cooking plate 14-16 cm
  - 4 Single-circuit cooking plate 18-20 cm
- is list of advised diameter of pots to be used on related burners.



### **DANGER**

#### **Broken glass!**

Do not let any objects fall onto the hob. Even small objects (e.g. salt shaker) may damage the hob.

Do not use glass ceramic hobs with cracks. Water may enter into the cracks and cause a short circuit.

If the surface is damaged in any way (e. g. visible cracks), switch off the device immediately to reduce the risk of an electric shock.

Glass ceramic hob is equipped with an operation light and a hot zone warning indicator.

Hot zone warning indicator indicates the status of the active zone and it remains lit after the plate is turned off. When the temperature of the plate cools down to a level that it can be touched by hand, warning indicator turns off. Flickering of the hot zone warning indicator is not a failure.

### **Turning on the ceramic plates**

The hob control knobs are used for operating the plates. To obtain the desired cooking power, turn the hob control knobs to the corresponding level.

<b>Cooking level</b>	<b>1</b>	<b>2 – 3</b>	<b>4 – 6</b>
	warming	stewing, simmering	cooking, roasting, boiling

### **Turning off the ceramic plates**

Turn the plate knob to OFF (upper) position.

## 6 How to operate the oven

### General information on baking, roasting and grilling



**DANGER**  
**Risk of scalding by hot steam!**  
Take care when opening the oven door as steam may escape.

#### Tips for baking

- Use non-sticky coated appropriate metal plates or aluminum vessels or heat-resistant silicone molds.
- Make best use of the space on the rack.
- Place the baking mold in the middle of the shelf.
- Select the correct rack position before turning the oven or grill on. Do not change the rack position when the oven is hot.
- Keep the oven door closed.

#### Tips for roasting

- Treating whole chicken, turkey and big-piece meats with dressings such as lemon juice and black pepper before cooking will increase the cooking performance.
- It lasts about 15 to 30 minutes longer to roast the meat with bones when compared to roasting the same size of meat without bones.
- Each centimeter of the meat thickness requires approximately 4 to 5 minutes of cooking time.
- Let meat rest in the oven for about 10 minutes after the cooking time is over. The juice is better

distributed all over the roast and does not run out when the meat is cut.

- Fish should be placed on the middle or lower rack in a heat-resistant plate.

#### Tips for grilling

When meat, fish and poultry are grilled, they quickly get brown, have a nice crust and do not get dry. Flat pieces, meat skewers and sausages are particularly suited for grilling as are vegetables with high water content such as tomatoes and onions.

- Distribute the pieces to be grilled on the wire shelf or in the baking tray with wire shelf in such a way that the space covered does not exceed the size of the heater.
- Slide the wire shelf or baking tray with grill into the desired level in the oven. If you are grilling on the wire shelf, slide the baking tray to the lower rack to collect fats. Add some water in the tray for easy cleaning.



**NOTICE**  
**Fire danger due to food which is unsuitable for grilling!**  
Only use food for grilling which is suitable for intensive grilling heat. Do not place the food too far in the back of the grill. This is the hottest area and fat food may catch fire.

## How to operate the electric oven

### Switching off the electric oven

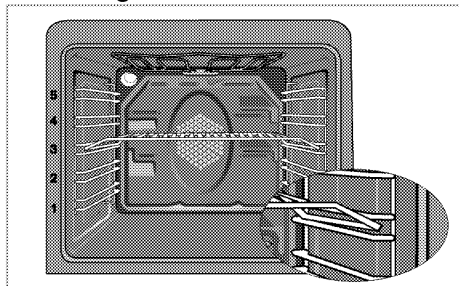

### Rack positions (For models with wire shelf)

It is important to place the wire shelf onto the side rack correctly. Wire shelf must be inserted between the side racks as illustrated in the figure.

Do not let the wire shelf stand against the rear wall of the oven. Slide your wire shelf to the front section of the rack and settle it with the help of the door in order to obtain a good grill performance.

### Operating modes

The order of operating modes shown here may be different from the arrangement on your product.

#### Top and bottom heating



Top and bottom heating are in operation. Food is heated simultaneously from the top and bottom. For example, it is suitable for cakes, pastries, or cakes and casseroles in baking moulds. Cook with one tray only.

#### Bottom heating



Only bottom heating is in operation. It is suitable for pizza and for subsequent browning of food from the bottom.

### Fan supported bottom/top heating



Top heating, bottom heating plus fan (in the rear wall) are in operation. Hot air is evenly distributed throughout the oven rapidly by means of the fan. Cook with one tray only.

### Operating with fan



The oven is not heated. Only the fan (in the rear wall) is in operation. Suitable for thawing frozen granular food slowly at room temperature and cooling down the cooked food.

### Fan Heating



Warm air heated by the rear heater is evenly distributed throughout the oven rapidly by means of the fan. It is suitable for cooking your meals in different rack levels and preheating is not required in most cases. Suitable for cooking with multi trays.

### "3D" function



Top heating, bottom heating and fan assisted heating (in the rear wall) are in operation. Food is cooked evenly and quickly all around. Cook with one tray only.

## Full grill



Large grill at the ceiling of the oven is in operation. It is suitable for grilling large amount of meat.

- Put big or medium-sized portions in correct rack position under the grill heater for grilling.
- Set the temperature to maximum level.
- Turn the food after half of the grilling time.

## Grill+Fan



Grilling effect is not as strong as in Full Grill

- Put small or medium-sized portions in correct shelf position under the grill heater for grilling.
- Set the desired temperature.
- Turn the food after half of the grilling time.

## Cooking times table



### Important

The values indicated in the table below are data indicative. They may vary according to the type of food as well as your preferences of cooking.













### Important

Level 1 is the **bottom** level in the oven.

## Baking and roasting

Dish	Cooking level number		Rack position	Temperature (°C)	Cooking time (approx. in min.)
Cakes in tray*	One level		4	175	30 ... 35
Cakes in mould*	One level		2	180	40 ... 50
Cakes in cooking paper*	One level		3	175	25 ... 30
	2 levels		1 - 5	175	30 ... 40
	3 levels		1 - 3 - 5	180	45 ... 55
Sponge cake*	One level		3	200	5 ... 10
	2 levels		1 - 5	175	18 ... 25
Cookies*	One level		3	175	20 ... 25
	2 levels		1 - 5	175	25 ... 30
	3 levels		1 - 3 - 5	175	30 ... 40
Dough pastry*	One level		2	200	30 ... 40
	2 levels		1 - 5	200	45 ... 55
	3 levels		1 - 3 - 5	200	55 ... 65
Rich pastry*	One level		2	200	25 ... 35
	2 levels		1 - 5	200	30 ... 40
	3 levels		1 - 3 - 5	190	40 ... 50
Leaven*	One level		2	200	35 ... 45

Dish	Cooking level number		Rack position	Temperature (°C)	Cooking time (approx. in min.)
	2 levels		1 - 3	200	35 ... 45
Lasagna*	One level		2 - 3	200	30 ... 40
Pizza*	One level		2	200 ... 220	15 ... 20
Beef steak (whole) / Roast	One level		3	25 min. 250/max, then 180 ... 190	100 ... 120
Leg of Lamb (casserole)	One level		3	25 min. 250/max, then 190	70 ... 90
Roasted chicken	One level		2	15 min. 250/max, then 180 ... 190	65 ... 70
	One level		2	15 min. 250/max, then 180 ... 190	55 ... 65
Turkey (5.5 kg)	One level		2	25 min. 250/max, then 180 ... 190	150 ... 210
	One level		2	25 min. 250/max, then 180 ... 190	150 ... 210
Fish	One level		3	200	20 ... 30
	One level		3	200	20 ... 30

When cooking with 2 trays at the same time, place the deeper tray on the upper rack and the other one on the lower rack.  
\* It is suggested to perform preheating for all foods.

In a cooking that requires preheating, preheat at the beginning of cooking until the thermostat lamp turns off.

### Tips for baking cake

- If the cake is too dry, increase the temperature by 10 and decrease the cooking time.
- If the cake is wet, use less liquid or lower the temperature by 10°C.
- If the cake is too dark on top, place it on a lower rack, lower the temperature and increase the cooking time.
- If cooked well on the inside but sticky on the outside use less liquid, lower the temperature and increase the cooking time.

### Tips for baking pastry

- If the pastry is too dry, increase the temperature by 10 and decrease the cooking time. Dampen the layers of dough with a sauce composed of milk, oil, egg and yoghurt.
- If the pastry takes too long to bake, pay care that the thickness of the

pastry you have prepared does not exceed the depth of the tray.

- If the upper side of the pastry gets browned, but the lower part is not cooked, make sure that the amount of sauce you have used for the pastry is not too much at the bottom of the pastry. Try to scatter the sauce equally between the dough layers and on the top of pastry for an even browning.

**i Important**

Cook the pastry in accordance with the mode and temperature given in the cooking table. If the bottom part is still not browned enough, place it on one lower rack next time.

### Tips for cooking vegetables

- If the vegetable dish runs out of juice and gets too dry, cook it in a pan with a lid instead of a tray. Closed vessels will preserve the juice of the dish.



- If a vegetable dish does not get cooked, boil the vegetables beforehand or prepare them like canned food and put in the oven.

## How to operate the grill



**WARNING**  
Hot surfaces may cause burns!  
Close oven door during grilling.

### Switching on the grill

1. Turn the Function knob to the desired grill symbol.
  2. Then, select the desired grilling temperature.
  3. If required, perform a preheating of about 5 minutes.
- » Temperature light turns on.

### Switching off the grill

1. Turn the Function knob to Off (top) position.

### Rack positions

Grill performance will decrease if the wire grill stands against rear part of the oven. Slide your wire grill to the front section of the rack and settle it with

### Cooking times table for grilling

#### Grilling with electric grill

Food	Insertion level	Grilling time (approx.)
Fish	4...5	20...25 min. <sup>#</sup>
Sliced chicken	4...5	25...35 min.
Lamb chops	4...5	20...25 min.
Roast beef	4...5	25...30 min. <sup>#</sup>
Veal chops	4...5	25...30 min. <sup>#</sup>
Toast bread	4	1...2 min.

<sup>#</sup> depending on thickness

the help of the door in order to obtain the best grill performance.

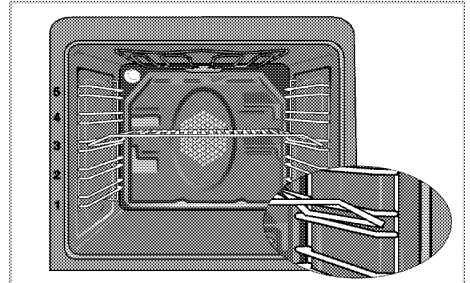



**NOTICE**  
Do not use the upper level for grilling.





**NOTICE**  
**Fire danger due to food which is unsuitable for grilling!**  
Only use food for grilling which is suitable for intensive grilling heat. Do not place the food too far in the back of the grill. This is the hottest area and fat food may catch fire.

## 7 Maintenance and care

### General information

Service life of the product will extend and the possibility of problems will decrease if the product is cleaned at regular intervals.

 **DANGER**  
**Risk of electric shock!**  
Switch off the electricity before cleaning appliance to avoid an electric shock.

 **DANGER**  
**Hot surfaces may cause burns!**  
Allow the appliance to cool down before you clean it.

- Clean the product thoroughly after each use. In this way it will be possible to remove cooking residues more easily, thus avoiding these from burning the next time the appliance is used.
- No special cleaning agents are required for cleaning the product. Use warm water with washing liquid, a soft cloth or sponge to clean the product and wipe it with a dry cloth.
- Always ensure any excess liquid is thoroughly wiped off after cleaning and any spillage is immediately wiped dry.
- Do not use cleaning agents that contain acid or chloride to clean the stainless or inox surfaces and the handle. Use a soft cloth with a liquid detergent (not abrasive) to

wipe those parts clean, paying attention to sweep in one direction.

 **NOTICE**  
The surface may get damaged by some detergents or cleaning materials.  
Do not use aggressive detergents, cleaning powder/cream or any sharp objects.

 **Important**  
Do not use steam cleaners for cleaning.

### Cleaning the hob

#### Glass ceramic surfaces

Wipe the glass ceramic surface using a piece of cloth dampened with cold water in a manner as not to leave any cleaning agent on it. Dry with a soft and dry cloth. Residues may cause damage on the glass ceramic surface when using the hob for the next time. Dried residues on the glass ceramic surface should under no circumstances be scraped with hook blades, steel wool or similar tools. Remove calcium stains (yellow stains) by a small amount of lime remover such as vinegar or lemon juice. You can also use suitable commercially available products.

If the surface is heavily soiled, apply the cleaning agent on a sponge and wait until it is absorbed well. Then, clean the surface of the hob with a damp cloth.

**i Important**  
 Sugar-based foods such as thick cream and syrup must be cleaned promptly without waiting the surface to cool down. Otherwise, glass ceramic surface may be damaged permanently.

Slight color fading may occur on coatings or other surfaces in time. This will not affect operation of the product. Color fading and stains on the glass ceramic surface is a normal condition, and not a defect.

### Cleaning the control panel

Clean the control panel and control knobs with a damp cloth and wipe them dry.

**i NOTICE**  
 Damage of the control panel!  
 Do not remove the control knobs for control panel cleaning.

### Cleaning the oven

#### To clean the side wall

1. Remove the front section of the side rack by pulling it in the opposite direction of the side wall.
2. Remove the side rack completely by pulling it towards you.

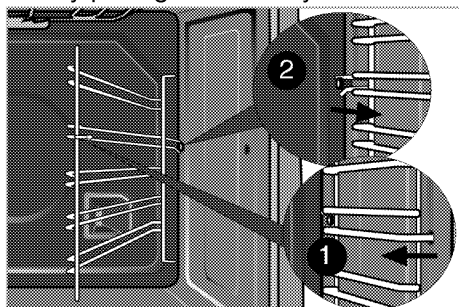

### Catalytic walls

Side walls or just back wall of oven interior may be covered with catalytic enamel.

The catalytic walls of the oven must not be cleaned. The porous surface of the walls is self-cleaning by absorbing and converting spitting fat (steam and carbon dioxide).

### Clean oven door

To clean the oven door, use warm water with washing liquid, a soft cloth or sponge to clean the product and wipe it with a dry cloth.

**i Important**  
 Don't use any harsh abrasive cleaners or sharp metal scrapers for cleaning the oven door. They could scratch the surface and destroy the glass.

### Removing the oven door

1. Open the front door (1).
2. Open the clips at the hinge housing (2) on the right and left hand sides of the front door by pressing them down as illustrated in the figure.

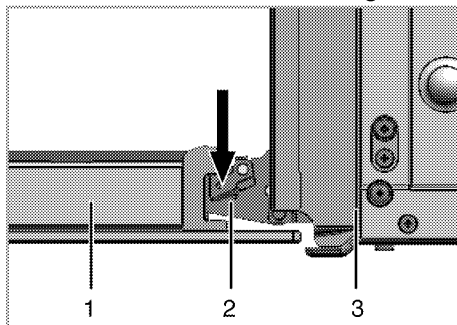

- 1 Front door
- 2 Hinge
- 3 Oven

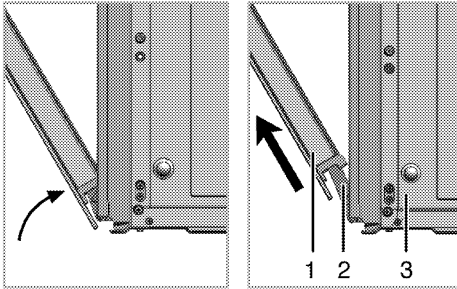

3. Move the front door to half-way.
4. Remove the front door by pulling it upwards to release it from the right and left hinges.

### **i** NOTICE

Steps carried out during removing process should be performed in reverse order to install the door. Do not forget to close the clips at the hinge housing when reinstalling the door.

## Replacing the oven lamp

### **!** DANGER

**Hot surfaces may cause burns!**

Make sure that the appliance is switched off and cooled down in order to avoid the risk of an electrical shock.

### **i** Important

The oven lamp is a special electric light bulb that can resist up to 300 °C. See *Technical specifications, page 5* for details. Oven lamps can be obtained from Authorised Service Agents.

### **i** NOTICE

Position of lamp might vary from the figure.

### If your oven is equipped with a round lamp:

1. Disconnect the product from mains.
2. Turn the glass cover counter clockwise to remove it.

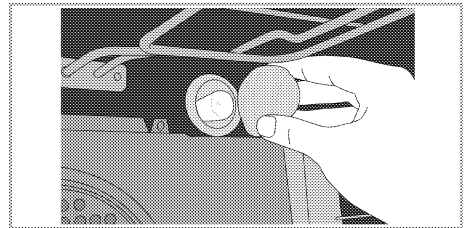

3. Remove the oven lamp by turning it counter clockwise and replace it with the new one.
4. Install the glass cover.

## 8 Troubleshooting

### ***Oven emits steam when it is in use.***

It is normal that steam escapes during operation. This is not a fault.

### ***Water drops occur during cooking***

The vapour that arises during cooking can condense and form water droplets when it hits cold surfaces of the product. This is not a fault.

### ***Product does not operate.***

The mains fuse is defective or has tripped.

Check fuses in the fuse box. If necessary, replace or reset them.

### ***Oven light does not work.***

Oven lamp is defective.

Replace oven lamp.

Power is cut.

Check if there is power. Check the fuses in the fuse box. If necessary, replace or reset the fuses.

### ***Oven does not heat.***

Function and/or Temperature are not set.

Set the function and the temperature with the Function and/or Temperature knob/key.

Power is cut.

Check if there is power. Check the fuses in the fuse box. If necessary, replace or reset the fuses.



### **Important**

Consult the Authorised Service Agent or the dealer where you have purchased the product if you can not remedy the trouble although you have implemented the instructions in this section. Never attempt to repair a defective product yourself.

# PROOF OF PURCHASE

Proof of purchase will be required for the validation of all warranty claims. Documents suitable for proof of purchase include, but are not limited to the following:

- Delivery dockets;
- Retailer or supplier invoices;
- Credit card statements where the purchase of the appliances are clearly depicted.

The inability to provide proof of purchase will lead to the claim being treated as a service call with labour and parts costs being born by the claimant.

NOTE: There is no need to return this or any other warranty card to Electrical Distributors Australia Pty Ltd. Proof of purchase is the only requirement for warranty claim, please keep a copy of the purchase receipt with this warranty card.

## AUTHORISED SERVICE AGENTS

### NSW

ALL GENERAL WHITEGOODS  
4/11 HALLSTROM PLACE  
WETHERILL PARK 2164 NSW  
PH: 02 9756 1511  
FAX: 02 9756 1091

### VIC

MASTER TECH APPLIANCE SERVICES  
9 KIRKHAM ROAD  
DANDENONG STH VIC 3175  
PH: 1300 131 118  
FAX: 1300 366 705

### WA

DACAPS APPLIANCE PARTS AND SERVICE  
357 SEVENOAKS STREET  
CANNIGNTON WA 6107  
PH: 1800 322 277  
FAX: 1800 354 310

### SA

PRESTIGE APPLIANCE SERVICE  
UNIT 4/ 65 STEPHENS AVENUE  
TORRENSVILLE SA 5031  
PH: 08 8352 2022  
FAX: 08 8352 2044

### QLD

ENDEAVOUR REFRIGERATION  
UNIT 1/ 22 ZILLMERE ROAD  
BOONDALL QLD 4034  
PH: 07 3137 3600  
FAX: 07 3137 3663

### QLD - GOLD COAST

ROSHAD APPLIANCE SERVICE  
1/13 LEDA DRIVE  
BURLEIGH QLD 4220  
PH: 07 5535 7044  
FAX: 07 5535 7407

### TAS

FARR ELECTRICAL CONTRACTOR  
369A ARGYLE STREET  
NORTH HOBART TAS 7002  
PH: 03 6231 0275  
FAX: 03 6231 0285

**FOR OUTSIDE SERVICE AREAS PLEASE CONTACT OUR SERVICE & CARE CENTRE  
PH: 02 4920 9114**



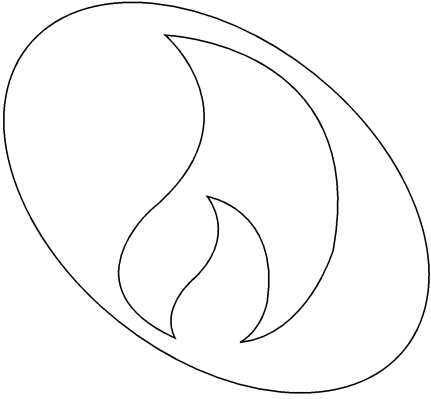

ÇAN kökü yapılmış yapı

### Data Label

ÇAN kökü yapılmış yapı

Printed in Turkey

Part no.

Revision no. R.AA - 27.02.2012