

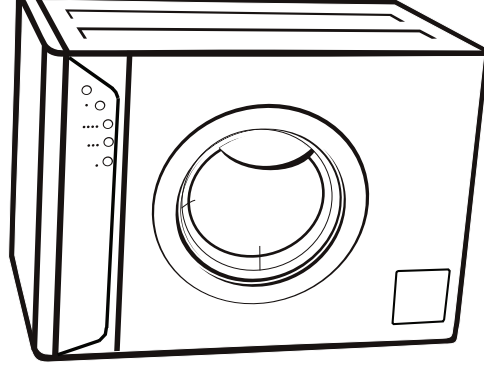

Electronic Clothes
Dryer

DE6KG
6.0kg



Please keep this manual in a safe place
Thanks for buying this new electronic clothes dryer

Manual of
Instruction

Please read this manual of instruction carefully before you use this product

WARNINGS



WARNINGS

1. Read before use:

- 1) Oil-affected items can ignite spontaneously, especially when exposed to heat sources such as in a tumble dryer. The items become warm, causing an oxidation reaction in the oil. Oxidation creates heat. If the heat can not escape, the items can become hot enough to catch fire. Piling, stacking or storing oil affected items can prevent heat from escaping and so create a fire hazard.
- 2) If it is unavoidable that fabrics that contain vegetable or cooking oil or have been contaminated by hair care products be placed in a tumble dryer they should first be washed in hot water with extra detergent—this will reduce, but not eliminate, the hazard.
- 3) The final part of a tumble dryer cycle occurs without heat (cool down cycle) to ensure that the items are left at a temperature that ensures that the items will not be damaged.
Warning: Never stop a tumble dryer before the end of the drying cycle unless all items are quickly removed and spread out so that the heat is dissipated.
- 4) This dryer has ventilation openings in the base, carpet must not obstruct the openings.
- 5) The dryer must not be installed behind a lockable door, a sliding door or a door with a hinge on the opposite side to that of the tumble dryer in such a way that a full opening of the tumble dryer door is restricted.
- 6) This appliance is not intended for use by persons (including children) with reduced physical, sensory or mental capabilities, or lack of experience and knowledge, unless they have been given supervision or instructions concerning use of the appliance by a person responsible for their safety.
- 7) Children should be supervised to ensure that they don't play with the appliance.

WARNINGS



- 8) The lint trap has to be cleaned frequently, lint must not be allowed to accumulate around the tumble dryer.
- 9) The tumble dryer is not to be used if industrial chemicals have been used for cleaning.
- 10) Caution, risk of fire symbol—This appliance has a risk of fire, caution should be enforced while operating.
- 11) Items that have been soiled with substances such as cooking oil, acetone, alcohol, petrol, kerosene, spot removers, turpentine, waxes and wax removers should be washed in hot water with an extra amount of detergent before being dried in the tumble dryer.
- 12) Items such as foam rubber (latex foam), shower caps, waterproof textiles, rubber backed articles and clothes or pillows fitted with foam rubber pads should not be dried in the tumble dryer.
- 13) If the supply cord is damaged, it must be replaced by the manufacturer or its service agent or a similarly qualified person in order to avoid a hazard.
- 14) Fabric softeners or similar products should not be used in a tumble dryer to eliminate the effects of static electricity unless this practice is specifically recommended by the manufacturer of the fabric softener or product.
- 15) Undergarments that contain metal reinforcements should not be placed in a tumble dryer.
Damage to the tumble dryer can result if metal reinforcements come loose during drying. When available a drying rack could be used for such items.
- 16) Lint must not be allowed to accumulate around the dryer. Not applicable for appliances intended to be vented.
- 17) If appliance is to be located on top of a washing machine, instructions shall state which washing machines are suitable and instruction on fixing.
- 18) Plastic articles such as shower caps or babies' waterproof napkin covers should not be placed in a tumble dryer.



- 19) Adequate ventilation has to be provided to avoid the back flow of gases into the room from appliances burning other fuels, including open fires.
- 20) CAUTION-If this appliance is supplied from a cord extension set or an electrical portable device, the cord extension set or electrical portable device must be positioned so that it is not subjected to splashing or ingress of moisture.

2. When using :

- If the drying process can operate while the door is open it should be sent to maintenance.
- If the drying process can operate without pushing the "START/PAUSE" button it should be sent to maintenance.
- This dryer is not intended to be placed on top of a washing machine.

CAUTION:

1. Be sure to clean filter lint before each load.
2. Keep the venting hole clean.
3. Dry only fabrics cleaned in water.
4. Keep away from children.
5. Do not hang things on the door.

WARNING:

To avoid fire hazard. Do not dry flammable articles, containing foam rubber or material on which you have used a cleaning solvent or which contains flammable liquids or solids (such as petrol, kerosene, vegetable or cooking oils, wax etc.)

Features 2

Part Name 3

Installation before use 3

Simple Installation 6

Operation Explanation 7

1.Preparing before drying 7

2.Check filter 7

3.Put clothes into the dryer..... 7

4.Close the door 8

5.Instruction on control panel 8

6.End of Program10

7. Take out the Plug 10

8.Clear filter, cabinet and inner tub 10

Other Functions Description 11

Trouble Solution 11

Instruction of Upside Down 13

Service15

Specifications 17



Features

1. Luxurious unique design: Designed with a front load washing machine in mind.
2. Back vent: This allows the humid air from the clothes to be vented directly out the back of the unit.
3. Micro control: Simple and convenient operation with the help of electronics.
4. Large door window: Allows you to see the drying progress.
5. Wide opening angle: 150°.
6. Long life construction: Suitable capacity with anti-dust, anti-humidity, anti-shake and low noise features.
7. Max. Rated volume of dryer: 6.0 kg (Dry clothes)

Part name

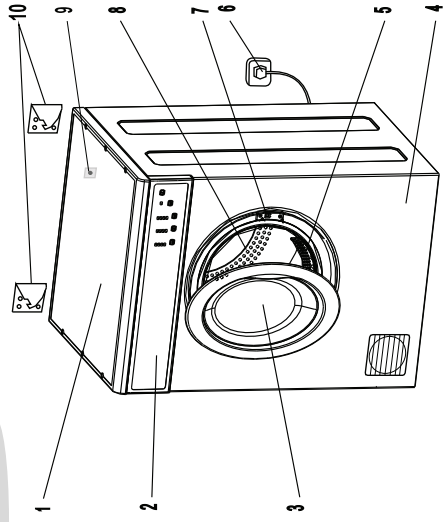

DE6KG

1. Topboard
2. Control panel
3. Door
4. Cabinet
5. Filter
6. Power lead
7. Door lock
8. Tumbling box
9. Reset button
10. Wall mounts

Installation before use

Step 1: Power source and grounding.

The dryer employs alternative current with the rated voltage and frequency. When the voltage fluctuates between 10% of rated voltage, the dryer can work normally. A special power socket for the dryer should be set aside the dryer for convenience and safety. The method of connection of the socket is as the figure below.

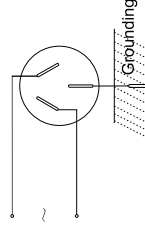





⚠ Notices:

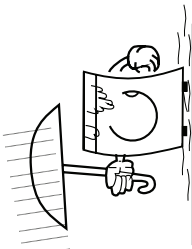
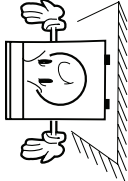
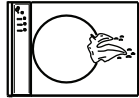

The socket and the grounding wire must be installed by an electrician to prevent incorrect installation or use of the socket and to guarantee the safety of use of electricity. The power wire of the dryer employs Y connection, if the supply cord is damaged, it must be replaced by the manufacturer, its service agent or similarly qualified persons in order to avoid a hazard. No connection of the grounding wire with the neutral wire, otherwise the cabinet will be charged, which is likely to cause the danger of electric shock.

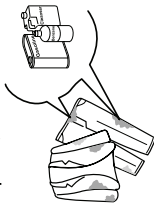
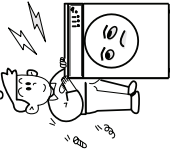
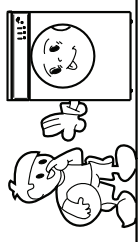

Step2: Precautions

<p>◆ Do not store or install the dryer where it will be exposed to water or the weather. If unavoidable, please dry the dryer before each use.</p> 	<p>◆ Please install dryer in a well ventilated area for better air circulation and to avoid obstructing air intake passage.</p> 
<p>◆ To avoid problems from wet clothes minimize risk, dehydrate items before placing inside the dryer.</p> 	<p>◆ Do not spray combustible aerosols near the dryer during use. If accidental spray occurs do not touch the plug or start/pause button.</p> 
<p>◆ Do not dry any clothes that are contaminated with combustible materials: i.e. Gasoline, methylated spirits, etc.</p> 	<p>◆ Don't operate this dryer if it is damaged, malfunctioning, partially disassembled or has missing or broken parts.</p> 
<p>◆ When the dryer is working, the back side will become hotter. In order to avoid such risk, The dryer is not intended for use by young children or infirm persons without supervision.</p> 	<p>◆ Please do not use the machine if your feet or hands are wet.</p> 

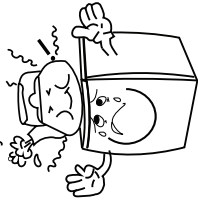

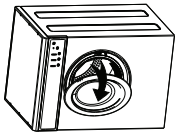
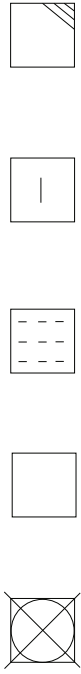
<p>◆ To avoid deformation of the control panel, do not place any heavy or hot articles on top of the dryer.</p> 	<p>◆ Do not try to dry raincoat or fluff clothes, or items containing rubber or elastic materials on any heat setting.</p> 
<p>◆ To avoid scalding, do not open the dryer door until the program has completed.</p> 	
<p>This product belongs to type I electronic products and please take note of safety problem accordingly:</p> <ol style="list-style-type: none"> 1.It is rule to use power which is buried in the earth and will not touch any socialequipments such as gas pipe or water pipe etc. Make sure the difference of different lines and they are not connected. 2.Please use special socket which is according to National Standard and will endure 10A current. <p>To be safe, please make improvements as soon as possible according to the rules and suggestions mentioned above.</p>	
<p>Clothes with the following markings shall not be dried in this dryer.</p>  <p>Not used for dryer in the tub Hang for dry Drip dry Flat dry Dry automatically</p>	



Simple Installation

Step 1:

Dryer should be placed in a ventilated area with no less than 10 cm distance from the wall. If placed in a room such as bath room, it is suggested there are no obstacles of 1.5m in front of dryer and it is kept ventilated.

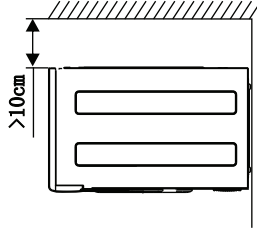

Step 2: The horizontal adjustment

Tie a heavy subject on the string on the front and two sides of the dryer. Please refer this to below figure, and if $A'=A$, $B'=B$, this means the dryer is placed horizontally. If the objects do not match up, something should be used to level the dryer.



Notice:

If the dryer is not placed horizontally (the lean angels is no more than 2°), the dryer will operate unbalanced and be more likely to fault.

Notice when installing:

- Do not install the dryer in the open air or place where easily damaged by water;
- Do not place the back of dryer near curtain or other obstacles;
- Do not place the dryer near gas or flammable materials.

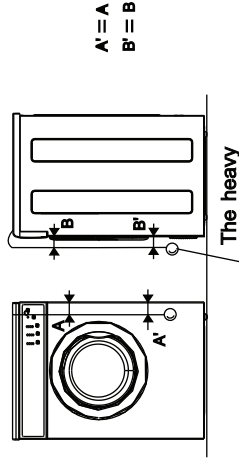

Operation explanation

1. Preparing before drying

- Clothes have to be washed and dehydrated before putting in the dryer.
- Put same kind clothes to dry together.
- Sort your clothes into loads that take a similar time to dry e.g. Heavier items from light items.
- Make sure the decorations and buttons are safe for high temperature and will not damage the inner tube of the dryer. Make sure the clothes are well protected.
- It is suggested to turn the clothes inside-out.
- Please check the clothes after washing, if there is dirt on clothes, the drying process cannot be relied on to remove the remaining dirt.
- Please make sure the power plug is well connected and the supply cord is in good condition.

2. Check filter

- Make sure the filter is well cleaned and in the right position.
- Filter must be cleaned regularly.

3. Put clothes into the dryer

- For faster results it is better put clothes with 1/2-2/3 the capacity of the inner tube for drying, because drying needs space to make clothes circulate evenly.
- When drying big clothes, it is better to include several small items to help balance the load.
- When drying expensive or little clothes (<1.5kg) it is better to add several towels whose fibers won't fall off easily, this will help dry the clothes more evenly.
- To avoid creased, rough or static electricity clothes, do not over dry.



The reference weight of dry clothing

Mixed-fabric clothes (about 800g)	Jacket (about 800g cotton)	Jeans (about 800g)	Towel quilt (about 900g cotton)
Single bedsheet (about 600g cotton)	Work clothes (about 1120g)	Sleepwear (about 200g)	Long sleeve shirt (about 300g cotton)
Short sleeve shirt (about 180g cotton)	Short pants (about 70g cotton)	Socks (about 50g mixed-weave)	

4. Close the door

5. Instruction on control panel

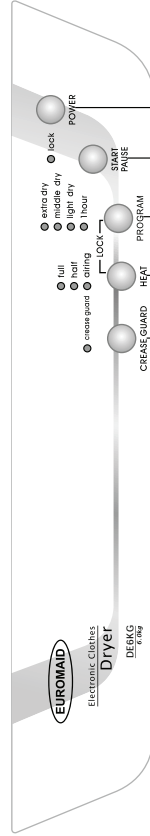

- ➊ POWER
- ➋ START / PAUSE
- ➌ PROGRAM (extra dry / middle dry / light dry / 1 hour)
- ➍ HEAT (full / half / airing)
- ➎ CREASE GUARD

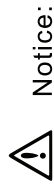

Notice:

Push PROGRAM and HEAT at the same time, this will enable the lock function. This can help avoid children playing with the device.

- 1) Push Power button.
- 2) Decide on a program according to the texture and capacity of the clothes. Select the program by pushing the "PROGRAM" button repetitively until the indicator light cycles to the desired program.
- 3) Decide on a temperature setting according to the texture and capacity of the clothes. Select the temperature setting by pushing the "HEAT" button repetitively until the indicator light cycles to the desired setting.
- 4) Press the "CREASE GUARD" button if expensive or easily creased clothes are being dried. Crease guard is indicated on/off via the "crease guard" light.
- 5) Push "START/PAUSE" button, this will start the program. If you wish to pause the program to add more clothes push the "START/PAUSE" button again. Be careful when opening dryer door, hot steam can release. To continue program, make sure the door is closed then push the "START/PAUSE" button once again. When the dryer is in pause mode it is possible to change or restart programs.
- 6) Control panel lock feature is initialized by pushing both "PROGRAM" and "HEAT" buttons at the same time. When the lock feature is enable it is indicated by a light, pushing the buttons again will disable this feature.
- 7) If the unit does not heat, push the reset button located at the back of the unit.

⚠ Notice: Push all buttons will cause a short buzzer with shining lights.

Program function setting

Program	Max volume of dry clothings	Temperature	Clothings type	Air-cold	Anti-crease	Child-lock	Max dry time
1 hour dry	4.0~6.0kg	full ✓	Quick drying clothes	10min	✓	✓	70min
	<4.0kg	half ✓					
Light dry	6.0kg	Air-dry ✓	Fine fabric and clothing not requiring heat to dry	10min	✓	✓	100min
	4.0~6.0kg	full ✓					
Middle dry	<4.0kg	half ✓	Chemical fiber and small clothing	10min	✓	✓	120min
	4.0~6.0kg	full ✓					
Extra dry	4.0~6.0kg	full ✓	Cotton weaving and jeans	10min	✓	✓	150min
	2.0~4.0kg	half ✓					
	<2.0kg	full ✓	Cotton clothes, jeans and bedsheets	10min	✓	✓	80min
			Cotton weaving and jeans	10min	✓	✓	

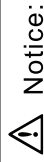

Notice:

● Cold air function circulates cold air for 10 minutes at the end of program. This ensures that the items are left at a temperature, and that the items will not be damaged. Crease Guard adds an extra 30s after the program to shake clothes in order to protect against creasing.



- Crease Guard means after programming, it adds extra 30s' one way running to shake clothes in order to protection of creasing.
- The inside temperature and humidity will not affect drying time.
- Check the label attached on clothes and choose the right temperature and time according to the explanation.
- The few clothes below 2.0kg shall be selected with "extra dry" program and "full" heat for drying.

6. End of Program

At the end of program, buzzer rings to remind take out clothes from dryer.

7. Take out the Plug

To be safe, please unplug the unit after each use.

8. Clear filter, cabinet and inner tub.

- Accumulated dust, fiber&debris will affect the air circulation inside the dryer this will cause longer drying times. It is advise to clean the filter and inner tube after each use.
- Make sure to cut off the power before clearing

Filter Clean

1)Remove filter

The lint filter is located in the door opening, remove the lint filter and open it out.

2)Clean filter

Wipe down with a damp cloth.

3)Re-fit filter

Once the filter is dry, re-fit into door opening.

4)Wipe the filter after using every time.

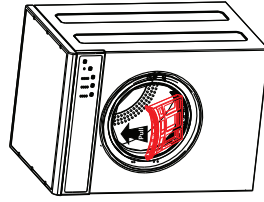

Cleaning cabinet and inner tube

Use a soft damp cloth to wipe the cabinet and inner tube.

- do not rinse by water directly
- do not use scour wipes
- do not use gasoline and alcohol wipes

Make sure open to the front door for aeration after cleaning the inner tube

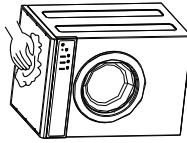

Other functions description

Step 1: Warning function

Fault	Cause of fault	Fault indication (lights)	Fault indication (sound)	Solution of alarm
Exceeded temperature alarm	The inner tube temperature exceeds 63°	"middle dry", "extra dry" indicator flash	The buzzer sounds for 10 seconds. If the program is not solved, the buzzer sounds every 15 minutes	Turn off the dryer, Wait for the dryer to cool down
Open door alarm	The door has opened during the program	"light dry", "middle dry" indication flash		Close door
Temperature sensor malfunction alarm	Program start sensor open	"1 hour", "light dry" indication flash		Reset the dryer. If the problem reoccurs return to manufacturer
	Program start sensor short	"1 hour", "middle dry" indication flash		

Step 2: Auto power-off function

- This machine will auto power-off after 10 minutes when you do not set any program.
- This machine will auto power-off after 6 time's buzzer on drying.

Trouble Solution



Trouble	Cause	Solution
Dryer won't start	<ul style="list-style-type: none"> ◆ Power cut ◆ Power plug not correctly connected ◆ Dry clothes exceed maximum volume ◆ Temperature fuse is cut 	<ul style="list-style-type: none"> ◆ Wait for power to restore ◆ Check the power socket and make sure plug is connected tight ◆ Remove clothes and check dampness, Max volume of the dryer is 8kg ◆ Please careerman exchange the temperature fuse
Dryer releasing extensive heat	<ul style="list-style-type: none"> ◆ Lint trap requires cleaning ◆ Intake or exhaust passage is obstructed 	<ul style="list-style-type: none"> ◆ Clean lint trap ◆ Clean air intake and exhaust and check for obstructions. (eg. Curtain)
Wet clothes	<ul style="list-style-type: none"> ◆ Dryer too full ◆ Clothes left in dryer too long after the end of the program ◆ Clothes not assorted properly ◆ Wrong temperature for clothes 	<ul style="list-style-type: none"> ◆ Make sure the dryer is not too full ◆ Immediately remove clothes when program finished ◆ See page 7. <p>Observe the maintenance label on clothes</p>
Shrinks clothes	<ul style="list-style-type: none"> ◆ Clothes over dried 	<ul style="list-style-type: none"> ◆ Observe the maintenance label on clothing. Remove clothes from dryer while still damp, finish drying process by hang drying.
Lint balls on clothing	<ul style="list-style-type: none"> ◆ Synthetic fibre rubbing with each other cause lint which attaches to clothes 	<ul style="list-style-type: none"> ◆ Use fabric softener. Please spray settled glue on cuff and neckline when ironing.

- If there is no heat from the dryer, please press the plastic push button at rear of dryer to activate the thermostat in order to reheat the element, please see illustration.



The sound of dryer when runs can cause

- Excessive noise of vibration: Due to heavy wet clothes turning and bumping.
- Air bumping: When drying, machine will generate steam which will come out from exhaust pipe. This will cause bumping with the bottom of the inner tub.

Instruction of Upside Down

Step 1: Fix two metallic hooks onto wall which align with the mounting slots of the dryer.

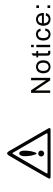

Notice:
Make sure the mounting wall is of sufficient strength to support the dryer weight.

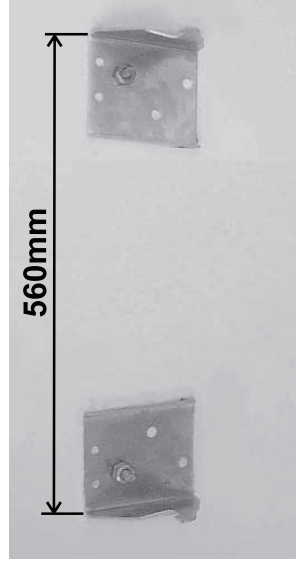

Step 2: To convert dryer turn anti clockwise 180°. Then place the plastic supports into their slots and turn them 90° to lock them into position.

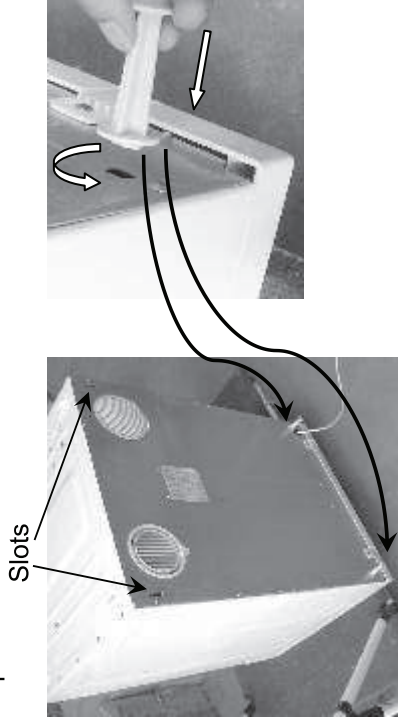



Step 3: Carefully raise the dryer and hang it onto the metallic hooks.
Slowly let the weight onto the hooks and let the plastic supports rest again the wall.

Warning: The dryer weight exceeds 35kg, please obtain assistance.

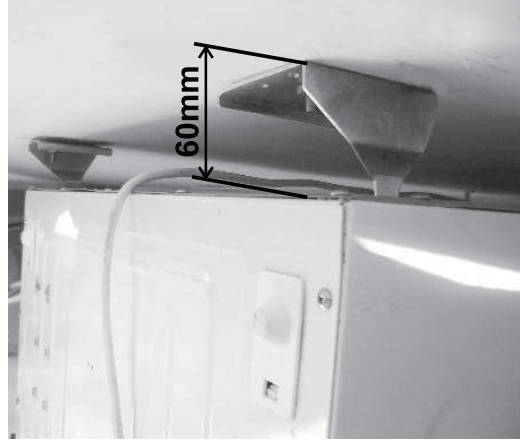

Step 4: Replace the panel sticker with the supplied inverted sticker.

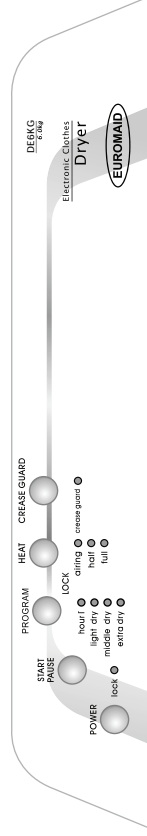

ELECTRICAL Distributors Service & Care Centre PTY LTD

ABN 11 051 297 557

1/9 TERAN CLOSE
WHITEBRIDGE NSW 2290

PH: 02 49 209114 FAX: 02 49209115

EMAIL: sales@euromaid.com.au WEBSITE: www.euromaid.com.au

EUROMAID CLOTHES DRYER WARRANTY

ADDITIONS TO RIGHTS BY LAW

Electrical Distributors Australia Pty Ltd guarantees to the original purchaser in the first **one year of ownership** that any part with defective material be replaced free of charge, provided that all service work is carried out by Electrical distributors Australia Pty Ltd or the nearest appointed service agent.

When the appliance is outside the normal service area of Electrical Distributors Australia Pty Ltd or its Appointed Service Agent the purchaser will pay the travel cost charges to take the appliance to the service centre. Please note that Electrical Distributors covers the first twenty kims.

Access must be granted within normal working hours and our Service Agents must have easy access to these appliances and charges will be the responsibility of the purchaser where the service technician cannot obtain easy access to remove the appliance for inspection prior to repair.



This Warranty is not transferable and excludes any repair or replacement caused by power surges abuse, Pest Damages, misuse, acts of God or accident. The above Warranty is for Domestic Application only and is limited to Three (3) Months in commercial applications.

Specifications

Dimension	595 × 530 × 840(mm)	Weight of product	32 Kg
Rated input power	1700W	Rated volume of dryer	6.0Kg (Dry clothes)
Rated voltage	220-240V ~	Rated frequency	50Hz

AUTHORISED SERVICE AGENTS:

ALL GENERAL WHITEGOODS
4/11 HALLSTROM PLACE
WETHERILL PARK NSW 2164
PHONE: 02 9756 1511

ENDEAVOUR REFRIGERATION SERV
1/22 Zillmere Road
BOONDALL QLD 4014
PHONE: 07 3872 7444

ROSHAD APPLIANCE
1/13 Leda Drive
BURLEIGH QLD 4220
PHONE: 07 5535 7044

MASTER TECH SERVICES
9 Kirkham Road
DANDENONG VIC 3175
PHONE: 1300 131 118

DACAPS APPLIANCE PARTS & SERVICE
357 SEVENOAKS STREET
CANNINGTON WA 6107
PH: 08 9358 6033

FARR ELECTRICAL
286 Macquarie Street
SOUTH HOBART TAS 7004
PHONE: 03 6223 1010

PRESTIGE APPLIANCE REPAIR CENTRE
4/65 Stephens Avenue
TORRENSVILLE SA 5031
PHONE: 08 8352 2022

**FOR OUTSIDE SERVICE AREAS, PLEASE CONTACT OUR SERVICE & CARE CENTRE AT
NEWCASTLE 02 49 209114**

